

9th IASTED European Conference on Power and Energy Systems 2009

(EuroPES 2009)

**Palma de Mallorca, Spain
7 – 9 September 2009**

Editors:

A.T. De Almeida

ISBN: 978-1-61567-750-4

Printed from e-media with permission by:

Curran Associates, Inc.
57 Morehouse Lane
Red Hook, NY 12571



Some format issues inherent in the e-media version may also appear in this print version.

Copyright© (2009) by ACTA Press
All rights reserved.

Printed by Curran Associates, Inc. (2010)

For permission requests, please contact ACTA Press
at the address below.

ACTA Press
B6 Suite 101
2509 Dieppe Avenue SW
Calgary, Alberta T3E 7J9
Canada

Phone: (403) 288-1195
Fax: (403) 247-6851

www.actapress.com

Additional copies of this publication are available from:

Curran Associates, Inc.
57 Morehouse Lane
Red Hook, NY 12571 USA
Phone: 845-758-0400
Fax: 845-758-2634
Email: curran@proceedings.com
Web: www.proceedings.com

TABLE OF CONTENTS

POWER SYSTEM CONTROL AND PROTECTION

Dynamic Analysis of Asymmetrical Faults Using Lyon Transformation	1
<i>S. Leva, A. P. Morando</i>	
An Identification of Active Power Imbalance Using Wavelet Transform	8
<i>S. Avdakovic, M. Music, A. Nuhanovic, M. Kusljagic</i>	
An Early Warning Protection Method Against Distribution Transformers Failure Due to Overloading	14
<i>E. I. Koufakis, P. T. Tsarabaris, J. S. Katsanis, A. D. Polykrati, S. D. Anagnostatos</i>	
Investigation Possibility of PCC Overvoltage Transients in Power Electric System with PAF	19
<i>B. Dobrucky, R. Pavlanin, M. Benova, M. A. R. Abdalmula</i>	
Methodology of Fault Location for Predictive Maintenance on Transmission Line	25
<i>C. R. Gomes, H. S. Gomes</i>	
0D Model of Thermal Exchanges at the Opening of an SF₆ High Voltage Circuit Breaker	32
<i>A. Ziani, H. Moulai</i>	
A Current Detection Based on an Extension of the Prony's Method	38
<i>D. Can, X. Xiangyang, G. Fen</i>	
Comparative Study Between Passive and Active Front-end Inverters With Respect to Inverter and Cable Losses	43
<i>J. Desmet, G. Vanalme, D. Howest, G. Pih, K. de Goedelaan, B. Kortruk</i>	

POWER QUALITY AND POWER ELECTRONICS

Intelligent Robust Control Law for Induction Motors Based on Field Oriented Control Theory	49
<i>O. Barambones, P. Alcorta, G. Sevillano, A. Garrido, I. Garrido</i>	
Estimation of Single-phase Uncontrolled Rectifier Parameters	57
<i>J. J. Mesas, L. Sainz, A. Ferrer</i>	
Deterministic and Experimental Study on Three-phase 6-Pulse Rectifiers	62
<i>J. J. Mesas, L. Sainz, A. Ferrer</i>	
Harmonic Currents Circulation in Electrical Networks Simulation and Analysis	67
<i>W. M. El-Mamlouk, M. A. El-Sharkawy, H. E. Mostafa</i>	
Hybrid Anti-resonance Capacitor System for Power Factor Correction	73
<i>L. Herman, B. Blazic, I Papic</i>	
New Series Active Power Filter for Computers Loads and Small Non-linear Loads	80
<i>M. Y. Tarnini</i>	
Embedding High-speed Power Electronics Simulations in Real-time Power System Simulations	86
<i>R. E. Crosbie, J. J. Zenor, R. Bednar, D. Word, N. G. Hingorani</i>	

POWER SYSTEM OPERATIONS AND STABILITY

Voltage Security Margin in Power Systems Using Fuzzy Inference System and QV Sensitivity Analysis	91
<i>D. Ceron, M. Rios, T. Herrera, A. Torres</i>	
Prediction of Security Margin Under Contingencies: A Fuzzy Inference System	97
<i>D. Ceron, M. Rios, J. Sanchez</i>	
A Suggestion of a Frequency Gradient Based Underfrequency Load Shedding Scheme	104
<i>U. Rudez, R. Mihalic</i>	
A Comprehensive Market-based Scheme for VAR Management and Pricing in the Electricity Markets	111
<i>E. E. El-Araby</i>	
A Feedback Linearization Based Generator Voltage Regulator for Power Systems	118
<i>G. Gurrala, I. Sen</i>	

Fuzzy Loads with Demand Side Contingency Management for Reliability Assessment of Restructured Power Systems	124
<i>A. P. Viswanath, L. Goel, P. Wang</i>	
Power Transfer Capability Assessment of Transmission Interfaces with SVC and Load Shedding Systems	132
<i>V. Pavlovsky, Y. Dolzhenitsa, K. Ushapovskiy</i>	
Design of Multi-machine Power System Stabilizer Using Evolutionary Algorithm	137
<i>S. Sheetekela, S. P. Chowdhury, K. A. Folly</i>	
Transient and Small Signal Stability of a Two Area HVAC Power Network Interconnected with an HVDC Link	141
<i>L. C. Azimoh, D. T. Oyedokun, S. Chowdhury, S. P. Chowdhury, K. A. Folly</i>	

RENEWABLE ENERGY SYSTEMS

Variable Structure Control for Maximum Wind Power Extraction	148
<i>O. Barambones, J. M. Gonzalez de Durana, P. Alcorta</i>	
Wind Power in Brazil: A Sustainable Energy	154
<i>R. Moreira da Silva, J. Reinaldo de Queiros</i>	
Reliability of Wind Power Plants in Cooperation with Power System Network	162
<i>J. Bargiel, W. Goc, P. Sowa, B. Tejchman</i>	
An Agent-based Multi-scale Wind Generation Model	166
<i>E. Kremers, N. Lewald, O. Barambones, J. M. Gonzalez de Durana</i>	
Theoretical Analysis of a Five-level Voltage Source Modular Inverter for Renewable Energy Applications	173
<i>G. P. Adam, O. Anaya-Lara, G. Burt</i>	
Thermal Analysis for Different Types of PV Panels	181
<i>C. Dainese, R. Faranda, S. Leva</i>	
Complete Agent Based Simulation of Mini-grids	188
<i>J. M. Gonzalez de Durana, O. Barambones, E. Kremers, P. Viejo</i>	
Review of Distributed Generation, Modeling and Its Impact on Power System Stability	193
<i>P. K. Olulope, S. P. Chowdhury, S. Chowdhury, K. A. Folly</i>	

ENERGY EFFICIENCY AND ENVIRONMENT

In-plane Flux Distribution in 45° T-Joint of 3Phase Transformer Core with Staggered Yoke and Limb 10MM	200
<i>I. Daut, D. M. M. Ahmad</i>	
Normal Flux Distribution in 45° T-Joint of Three Phase Transformer Core with Staggered Yoke and LIMB10MM	205
<i>I. Daut, D. M. M. Ahmad</i>	
Power Optimization of the Complex Pumping System	209
<i>A. Alexandrescu</i>	
A System for Outdoor Fire Detection and Suppression	215
<i>S. D. Anagnostatos, A. N. Proios, E. I. Koufakis, A. D. Polykrati, P. D. Bourkas</i>	
An Energy Saving System for Hospital Laundries	219
<i>J. S. Katsanis, P. T. Tsarabaris, E. I. Koufakis, A. D. Polykrati, A. N. Proios</i>	
Residential Behavioral Energy Savings: A Meta-regression Analysis	225
<i>K. H. Tiedemann</i>	
Energy Star Appliances and Energy Efficiency	230
<i>K. H. Tiedemann</i>	
Economics of Appliance Efficiency	235
<i>K. H. Tiedemann</i>	
Impact of a Residential Time of Use Rate on Peak, Off-peak and Total Energy Consumption	239
<i>K. H. Tiedemann</i>	

POWER TRANSMISSION AND DISTRIBUTION

Completely Decentralized State Estimation for Active Distribution Network	245
<i>P. H. Nguyen, W. L. Kling, J. M. A. Myrzik</i>	
Magnetic Field Measurements Under Two-pole Type Distribution Substations in the Low Frequency Range	251
<i>A. N. Proios, S. D. Anagnostatos, J. S. Katsanis, P. T. Tsarabaris, P. D. Bourkas</i>	
Real Time Monitoring of Radial Distribution System Through Optimal PSO Meter Location	255
<i>L. Ramesh, S. P. Chowdhury, S. Chowdhury, C. T. Gaunt</i>	
A Literature Review on Optimum Meter Placement Algorithms for Distribution State Estimation	263
<i>L. Ramesh, S. P. Chowdhury, S. Chowdhury, C. T. Gaunt</i>	
Optimal Point Tariffs in Transmission and Distribution Using Nonnegative Least Squares Estimates	272
<i>E. B. Hreinsson</i>	
Accidents By Electrical Contact of Heavy Vehicles with the Power Distribution Network Overhead Lines.....	277
<i>P. D. Bourkas, P. T. Tsarabaris, E. I. Koufakis, J. S. Katsanis, A. D. Polykrati</i>	
A Mathematical Model for Condition Monitoring of a Power Transmission Line	283
<i>P. V. Junior, M. A. S. Bobi, R. C. Limao, M. M. L. de Castro Negrao</i>	
Author Index	

AN AGENT-BASED MULTI-SCALE WIND GENERATION MODEL

Enrique Kremers¹, Norbert Lewald²
European Institute for Energy Research (EIFER)
Universität Karlsruhe (TH)
Emmy Noether Str. 11
D-76131 Karlsruhe, Germany
+49 (0) 721 6105-1451¹ -1374²
email¹: enrique.kremers@eifer.org
email²: norbert.lewald@eifer.org

Oscar Barambones³, José María González de Durana⁴
E. U. de Ingeniería de Vitoria-Gasteiz
Universidad del País Vasco
Nieves Cano, 12
E-01006 Vitoria, Spain
+34 945 01-4268³ -3228⁴
email³: oscar.barambones@ehu.es
email⁴: jtpgogaj@ehu.es

ABSTRACT

This paper presents an agent-based model for simulating wind power systems on multiple time scales. The aim is to generate a flexible model that allows us to simulate the output of a wind farm. The model is developed using multi-paradigm modelling, combining different approaches such as agent-based modelling, discrete events and dynamic systems. First, the theoretical background concerning the basic models for wind speed generation and power turbines is explained, as well as the fundamentals of agent-based modelling. After that, the implementation of these models is illustrated. In the next step, some sample simulations are shown and the application of the model is discussed. The proposed model aims to represent the wind power production by modelling wind farms consisting of wind turbine units on different time scales, taking into account fluctuating wind speeds and technical reliability. The model is able to compute the aggregated output power of the wind farm influenced by different random factors and can thus recreate a realistic power unit to be used in integral energy system simulations.

KEY WORDS

Wind Power, Wind Simulation, Hybrid Model, Agent-Based Model, Multi-Scale, Reliability

1 Introduction

Energy systems are undergoing a deep paradigm shift majorly since the past decade, caused by the introduction of renewable energies, the liberalisation of energy markets and the emergence of new, distributed producers that feed into the grid at almost every level of the system.

The general trend towards the introduction of renewable energy sources in the industrialised countries implies one of the greatest changes in the structure of energy systems. These systems are moving away from a centralised and hierarchical energy system, where the production follows a top-down principle under the strict control of the electricity supply companies towards a new system where diverse actors influence the energy supply. The production is no longer limited to large energy providers, as small de-

centralised producers now exist and inject energy at much lower tension levels than before. These energy systems are suffering the consequences of such a paradigm change. This change basically consists in new regulations and the introduction of new energy production technologies that transform traditional centralised systems into decentralised ones. This whole process is part of the framework of the fight against the causes of climate change, which is mostly due to CO₂ emissions. This paradigm change encompasses new tools and methods that can deal with decentralised decision-making, planning and self-organisation. The large amount of new actors and technologies in the energy production chain requires a shift from a top-down to a more bottom-up approach.

Multi-scale simulation systems offer several advantages over classical models. The ability to run simulations on different time scales using the same model is an important issue for the upcoming modelling of energy systems. The main advantages are that there are fewer models and no need to port data between platforms. This leads to a more efficient simulation run and decision-making support. The challenges of these kind of simulations are that a multi-scale model for the moment will not be as accurate as a purpose made model. So, the modelling method, the parameters, etc. included must be carefully chosen to ensure both flexibility and accuracy.

The work presented in this paper concerns the wind generation module of an agent-based model for integral energy systems developed at the European Institute for Energy Research (EIFER). The module is able to generate simulated power output data for wind farms on different timescales, ranging from short (minutes) to long-term simulations (months). The simulation of this data is performed in real time, i.e. so that the power output at a specific time can be reproduced and injected into the energy system simulation. The main points of the model are temporal scalability (to integrate different time scale simulations into the same module and reduce the number of modules), generalisation (to ensure the application of the model to any kind of wind turbines and be able to simulate a wide range of wind farms) and the creation of a model that is able to simulate real time data with only the necessary entry parameters.

2 Stochastic wind speed simulation

Generating realistic wind speeds is an important task when the effects of wind production in an electricity system have to be analysed. The fluctuating wind speed is the origin of the temporal variation of the power injected by this production type and thus has direct effects on the grid stability. One of the challenges of wind speed simulators is mainly to reproduce the different scale term fluctuations, as described in [1]. To this end, different models have been developed during the past decades. The model chosen here is built up in two steps, comprising two components, a slow and a fast called and is the same as in [2] with some minor modifications. More accurate wind models (that take into consideration e.g. long-term [3] or cross-correlations [4]) are available, but this one should be sufficient for the purposes of this work. An overview of some more approaches can be found in [5]. It is important to add that to get a realistic simulation of a specific site, records of historical data are needed to obtain the parameters of the model, as even the best model is useless if not accurately fitted.

2.1 The slow component

The first part, which was already used in a previous work of the author [6] is a generator of hourly mean wind speeds. This time series model is based on an ARMA (Auto-Regressive Moving-Average) model which is given by

$$y_t = \phi_1 y_{t-1} + \phi_2 y_{t-2} + \dots + \phi_n y_{t-n} + \alpha_t + \theta_1 \alpha_{t-1} + \theta_2 \alpha_{t-2} + \dots + \theta_m \alpha_{t-m} \quad (1)$$

The data series y_t is used to build the model, i.e. to calculate the auto-regressive ϕ_i $i = 1, 2, \dots, n$ and the moving average parameters θ_j $j = 1, 2, \dots, m$. $\{\alpha_t\}$ is a Gaussian white noise process with zero mean and standard deviation of σ_α which is part of the moving average (MA) part of the model. Considering the orders, the process is referred to as ARMA(n, m). The parameters used in this work were chosen from an ARMA(3,2) approach, but the model was developed up to ARMA(4,3) and can be easily adapted to other orders. For example, a pure AR(2) model [5] which was also implemented before can be seen as a as an ARMA model with $n = 2$ and $m = 0$. The order of the model depends on the quantity of historical data available, since, if there is only a little data, an accurate model cannot be reached even with higher orders. There is a range of literature available regarding parameter estimation. Fitting models are normally based on the least squares regression methods that try to minimise the error value. For AR parameter estimation, the Yule-Walker equations are widely used.

The simulated hourly mean wind speed [3] can be obtained by

$$\bar{v}_1(t) = \mu + y_t \quad (2)$$

where μ is the mean wind speed of all the observed data. If observed hourly mean speeds μ_h and standard deviations

σ_h are available, a more realistic simulated wind speed can be calculated as:

$$\bar{v}_2(t) = \mu_h + \sigma_h \cdot y_t \quad (3)$$

The method is explained in detail in [3].

2.2 The fast component

Being able to compute hourly mean wind speeds might be enough for several applications of the energy systems model, but as temporal scalability was a requirement for the latter, a more detailed model was needed. The ability to reproduce realistic wind speeds in real time can be gained by adding a so called fast component to the previously described slowly varying signal. For this purpose turbulent phenomena are modelled by a highly fluctuating signal given in [2] by the following differential equation:

$$\frac{dw}{dt}(t) = -\frac{w(t)}{T} + \kappa v_h(t) \sqrt{\frac{2}{T}} \xi(t) \quad (4)$$

where $T = L/\bar{v}$, being L the turbulence length scale, κ a factor that depends on the geographical location of the wind turbine site [7], $\xi(t)$ a Gaussian white noise and $v_h(t)$ the hourly mean wind speed. The equation describes a stationary Gaussian process. This component allows us to generate a time continuous signal that represents a real time wind speed.

3 Turbine model

There are plenty of technical models for wind turbines. The model used here is a generic approach, which takes into consideration the agent-based approach of the framework. As the wind turbine has to be able to be replicated (in order to create wind farms with tens or even more turbines), a simple model was chosen to ensure fluid simulations. The basis of this model is the relation between the power output of the turbine, which is a function of the wind speed acting on its rotor blades. Three different models that are commonly used have been identified in the course of this work. The *real model* is not a mathematical model itself. It just shows the $P(v)$ curve of a specific turbine - based on the manufacturer's data. In general, the curve has a shape similar to the one shown in Figure 1.

The curve shows the typical profile of a wind turbine. The cut-in speed is the minimum wind speed at which the turbine can start working, the nominal wind speed is the point at which rated power of the turbine is achieved. This power is normally almost constant up until the cut off wind speed is reached, at this point the turbine must be shut down to avoid damage caused by too strong winds. So, four principal working states can be defined as:

- Stopped: for $v < v_{cut-in}$
- Partial load: for $v_{cut-in} < v < v_{nom}$

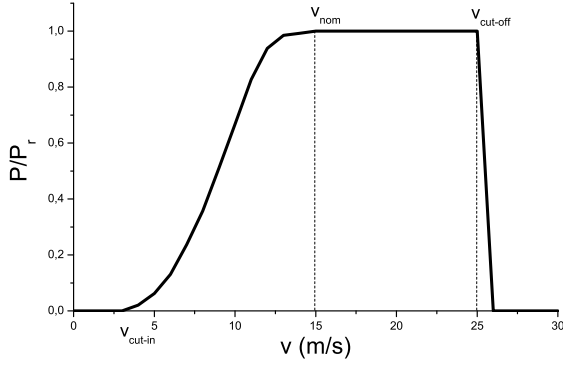

Figure 1. A sample power curve. P_r is the rated power

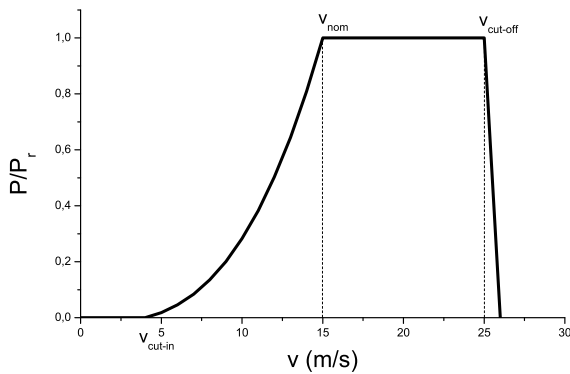

Figure 2. Polynomial approximated power curve

- Rated load: for $v_{nom} < v < v_{cut-off}$
- Cut-off: for $v > v_{cut-off}$

The transitions between the states are smooth because of the technical characteristics of the rotor and generator in the real curve. The most interesting state to be observed is the partially loaded state, where the turbine shows a non-linear $P(v)$ dependence. Here it can be observed the start dynamics of the turbine as well as the adaptation to the fully loaded capacity at rated speed. This phase can be approximated by a polynomial term as shown in Figure 2. The polynomial model assures the curved shape of the curve, but the trace just before achieving the nominal wind speed is idealised. The linear approximation of the curve, which is used in more simplified models, can be defined by linearly interpolating the values for v_{cut-in} and v_{nom} . It can be seen in Figure 3. The last model might have use when only the characteristic wind speeds of the turbine (and no power curve) are available. Though, the polynomial approach can be also be used as approximation by using a polynomial of degree three as described in [8].

The cut-off state is reached when the turbine gets shut-down because of exceeding $v_{cut-off}$. Further, a

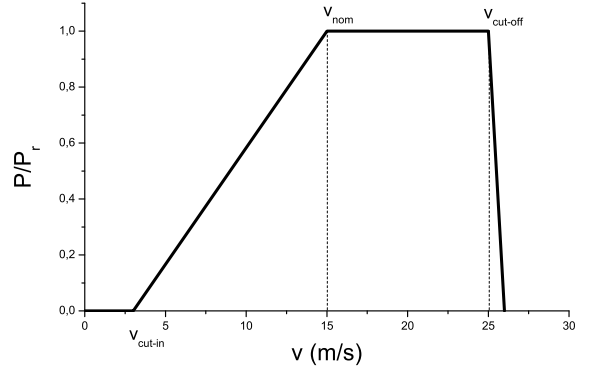

Figure 3. Linear simplified power curve

$v_{cut-back-in}$ parameter can be defined for the model. Its value denotes the wind speed, at which the turbine gets back to work after having entered the cut-off state. This value adds the restart behaviour of the machines after strong wind periods.

Being MTBF the Mean Time Between Failures of a unit defined by

$$MTBF = \frac{1}{\lambda} = \frac{\text{operational time}}{\text{number of failures}} \quad (5)$$

where λ is the failure rate. Using $MTBF$ allows modelling the availability of a wind turbine over time. The equation describing the Mean Time To Recover

$$MTTR = \frac{\text{down time}}{\text{number of failures}} \quad (6)$$

is also included, where *down time* is the time when the turbine is inactive because of a failure, maintenance or reparations. The MTTR is so an indicator for the average time until the unit gets started up again after an incident. Considering these two parameters, a failure model is integrated into the turbine model. The rates (inverse values of them) are used to determine failure probability used in the transition among states.

4 Agent-based modelling

Agent-based modelling is a technique that is gaining more and more importance during the past two decades. An agent-based model combines the use of small, reproducible entities called agents, that interact among themselves and with an environment and lead to complex system behaviour like emergence. These models possess several characteristic, as they can create a wide solution space and allow the appearance of distributed intelligence. They are commonly used to obtain decentralised solutions where a central controlled solution method is not applicable. These include open or at least very dynamic environments, systems constituted naturally by agents and systems that have to be eas-

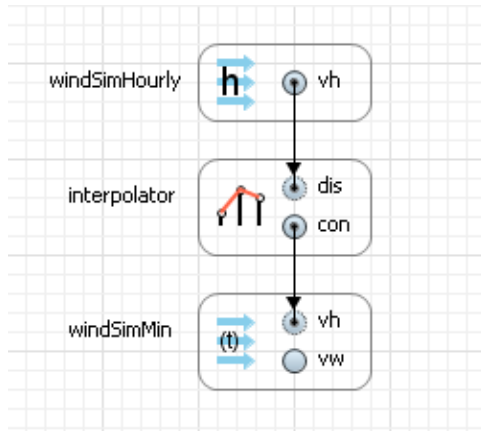

Figure 4. Modules of the wind simulator

ily extendible or scaleable. A detailed introduction to the subject is given by Wooldridge in [9].

5 Implementation

5.1 Wind simulator implementation

To build the wind simulator, different modules were developed in Anylogic, a software package from XJ Technologies [10]. Each module was encapsulated to work independently and has well defined interfaces. The wind simulator modules are the following:

- **Hourly simulator:** The hourly simulator implements the slow component ARMA model described in section 2.1. The parameters of the model are the hourly mean wind speed μ_h , the hourly standard deviation σ_h , the standard deviation σ_α of the $\{\alpha_t\}$ process and the AR and MA coefficients $\phi_1 \dots \phi_4$ and $\theta_1 \dots \theta_4$, respectively. The output generated is the hourly mean wind speed $v_h(t) = \bar{v}_2(t)$ by implementing the method described in Equation (3).
- **Detailed simulator:** The detailed simulator is needed for short time-scale wind simulations. It is the implementation of the fast component using an average hourly wind speed as input. The input signal $v_h(t)$ is superposed with some turbulences. This can be fitted to real turbulence data by the parameters κ and L described in Section 2.2. The solution to the differential equation is computed by Anylogic's engine using the Euler method.
- **Interpolator:** The interpolator module is necessary to generate smoothed final wind speeds. As the hourly mean wind speed is calculated in discrete values for each step, the change of the mean would cause a non continuous piecewise function with abrupt jumps in the final wind speed signal. Thus, a linear interpolation for the hourly wind speed was implemented. The

module owns a parameter to determine the interpolation interval t_i measured in time steps of the current model time. It is interconnected between the hourly simulator and the detailed simulator, as shown in Figure 4.

5.2 Turbine implementation

The wind turbine is the core of wind power production. The requirements of the turbine were to convert the wind speed to a suitable magnitude for the power system, i.e. the injected power. This reflects the process of the wind turbine converting the kinetic energy of the wind into electric energy by means of the generator. The wind turbine is modelled as an agent, because it will be replicated several times to create wind farms and each entity has similar but not exactly identical characteristics. The agent can be customised through its parameters, which are shown in Table 1.

Making use of Anylogic's features to create hybrid models [11], the turbine was modelled using the power curve model of the $P(v)$ relation described in Section 3 in combination with UML statecharts. The power curve model was chosen to ensure flexibility in the application of the model. It is assumed that when modelling a wind farm, detailed information about the used turbines is available.

The statechart elaborated here is classified in states dependent on the output power and failure state. The three working states of the turbine are as follows:

- **Off:** this state is active when the turbine is not producing any output power, regardless of the cause (no wind, too strong wind speeds, etc.) except in the case of a failure
- **Failure:** this state is achieved when there is a failure or a shutdown of the turbine due to maintenance.
- **On:** the turbine is in this state when producing output power, regardless if the rated power is gained or the turbine is only partial loaded.

The transition conditions between the states are defined by the wind speed for the transitions between the *On* and *Off* states, and by the corresponding rates of the MTBF and MTTR in the case of transitions to and from the *Failure* state, respectively. The MTBF is used for both transitions from the *On* and *Off* states. The rates are always adapted

Table 1. Wind turbine parameters

Parameter	Description	Value
P_{nom}	Nominal power	275 kW
v_{cut-in}	Cut-in wind speed	3 m/s
$v_{cut-off}$	Cut-off wind speed	20 m/s
$v_{cut-back-in}$	Cut-back-in wind speed	18 m/s
$MTBF$	Mean Time Between Failures	1900 h
$MTTR$	Mean Time To Recover	80 h

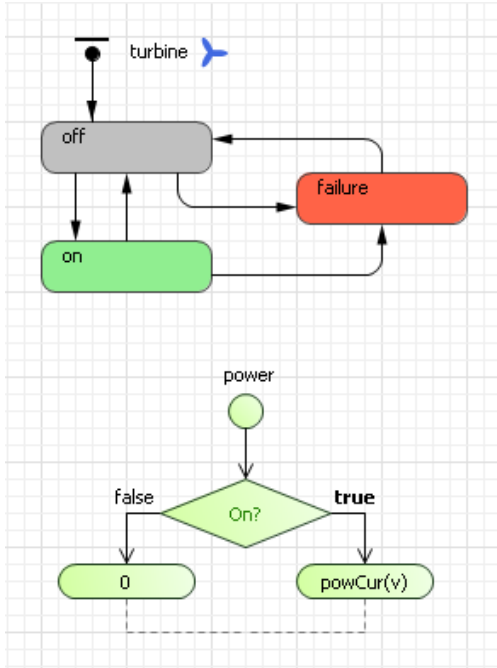

Figure 5. State and actionchart of a wind turbine

to the current timescale by a factor that is proportional to it and set automatically by the model in function of the scale chosen.

For the computation of the output power, the so-called actionchart of Anylogic is used to link both the discrete statechart approach with the continuous power curve. The output power is only taken from the power curve, if the current state is set to *On*. Both the statechart and the actionchart are shown in Figure 5.

6 Integral multi-scale wind power simulation

Having implemented the basic elements of our simulation, the wind turbine agents are grouped into an environment that defines common values for all agents within it and creates a framework among them that allows us to extract common statistical data. For instance, the aggregated output power of the wind farm is computed by its use.

In the current sample a wind farm with 25 wind turbines is generated. This is a typical number for medium size onshore wind farms. The power curve of the generators is the same for all, since it is assumed that the same type of turbines are installed. The power curve used here is inspired by the turbine type GEV MP 275 from the manufacturer Vergnet Eolien. It has a 32m diameter rotor and a rated power of 275kW and is specially designed to be used in remote locations and can sustain hurricane winds when secured to the ground.

The wind parameters for the wind simulator were taken from models developed previously. The ARMA co-

efficients used for the hourly simulations were taken from [12] for the "North Battleford" site. The parameters L and κ were taken from [7].

6.1 Simulation of wind speed at different scales

In Figure 7 wind speed as a comparison between hourly mean and continuous simulation is shown. Both the mean wind speed $v_h(t)$ and the simulated real-time speed (fast term using the last one as input) $v_w(t)$ are shown in the first plot. The output of two wind farms is plotted below. The simulated wind farms are identical, and ideal functioning was supposed (no failures or shut downs). The difference between them is the wind speed input data. The first farm takes the interpolated hourly mean wind speeds, the second one the real time speeds.

As can be seen on the plots, over 5 days the output of each method differs strongly only in some cases. There are some points where $v_w(t) > v_{cut-off}$. The turbines shut down because of over speed reasons in this case, but looking at the same point in the hourly mean simulation, there is not such a power drop. This is because $v_w(t)$ surpasses the hourly mean $v_h(t)$ punctually. To reach a power drop in the hourly simulation, $v_h(t) > v_{cut-off}$ is needed. These drops are a problem for the grid stability, as they are very significant and occur in a short time. Indeed, control mechanisms of the wind farms that shut down turbines proactively depending on wind speed forecasts or similar to prevent such abrupt drops have not been considered yet. Furthermore, the rapidly fluctuating wind speed component is transmitted to the power output of the second wind farm, while the curve of the first one is much smoother.

This is an example of how the model can be adapted to different of energy system simulation requirements. If short term data is needed, a real-time simulation can be run in order to get data that is continuous in time. If the simulation takes place over the medium term, i.e. some weeks or months, hourly mean speeds are used and the fast term component module is deactivated, giving a more effi-

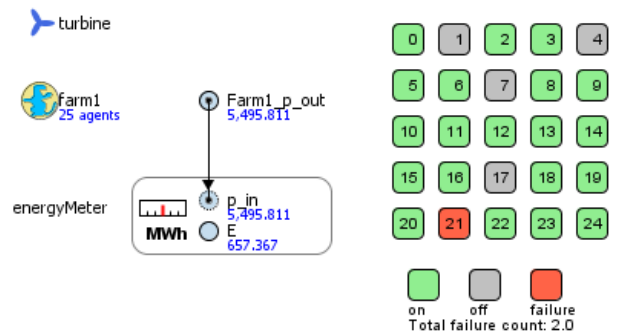

Figure 6. Representation of the states of the turbines composing a wind farm

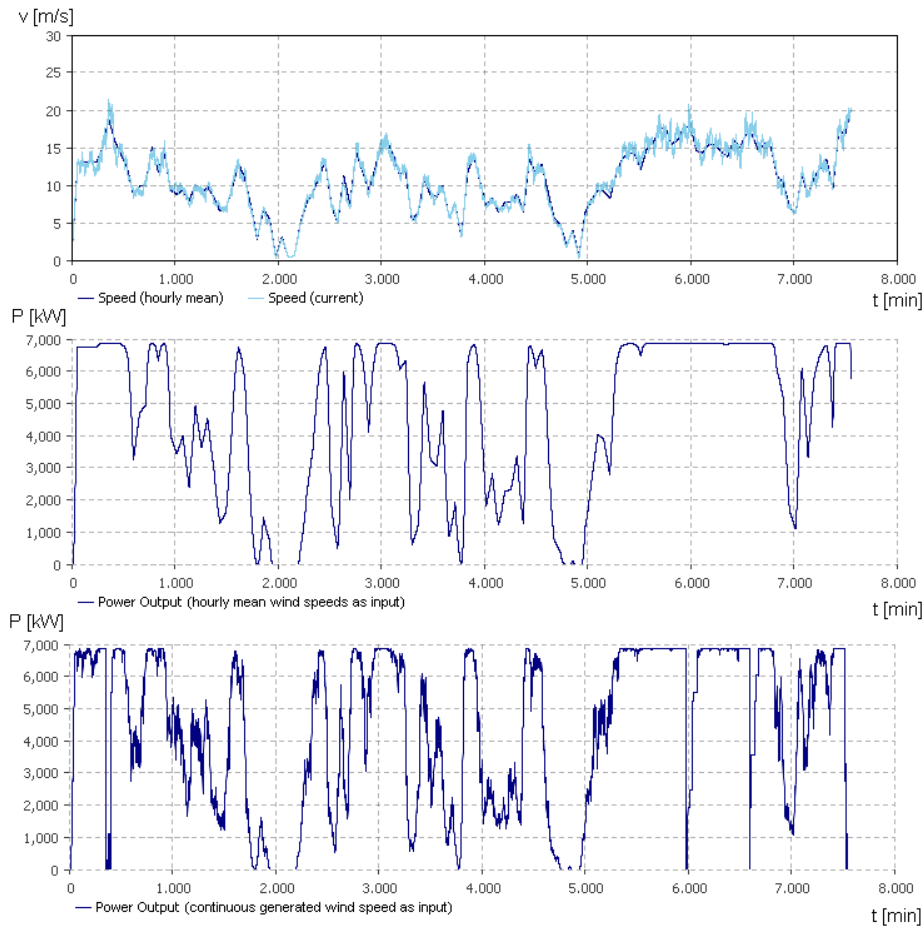

Figure 7. Comparison hourly and continuous simulation for a period of 7.500 minutes

cient computation. For long-term simulations, the statistical data provided for the simulation can be used to compute monthly energy output of wind farms.

6.2 Failure behaviour of the turbine units

As explained previously, the turbine model is provided with a failure function that allows us to simulate technical failures using specific parameters that can be obtained empirically. In this way, failures of individual units are randomly simulated over time. The average time to restart the turbines after such a failure is also considered.

In Figure 6 the representation of the turbines and their current state is shown. The model can easily show the state of each turbine and the aggregated current output and energy production. Also the state of an individual generator and its production values can be observed. The inclusion of the failure behaviour in real-time allows us to consider its direct influence on the power output of the farm within the same model.

6.3 Distributed parameters

All turbine manufacturers provide technical specifications that document their characteristics in detail. The values shown in these documentation normally are not specified for each unit individually, as they are obtained using average values for all units of the same type. Although the units are supposed to be identical in construction, small differences cannot be avoided.

To model this heterogeneity among the same units, the parameters of the turbines were slightly varied among themselves, by distributing them normally with a mean $\mu_{[value]}$ corresponding to the indicated value and a small standard deviation of $\sigma_{[value]} = 0.1\mu_{[value]}$. Further studies could get exact values for the variation of parameters among different units. This leads to small variations in the behaviour of each unit, that can result in aggregated effects on the wind farm output, and which are usually not considered in classical models. One of the strengths of the model is that it relies on the heterogeneous modelling of the individual agents.

7 Conclusion

The current work allows us to simulate wind power generation at different timescales using the same model. The characteristics of the model are maintained at the different scales. So, for example, failure behaviour is modelled and can affect also short term simulations, if needed. Developing the model, the following scope could be made:

- The primary aim of the model is not to estimate the accumulated energy productions over a period (used for example for the dimensioning of wind farms) but rather to simulate real time power outputs for energy system simulations.
- The wind direction is not taken into account for the moment, so the turbines are supposed to follow it fairly well.
- The continuous simulation could be replaced by a minute by minute one, as the power output is not as directly coupled to wind speed as represented in the model, because of inertia of the rotor and modern automatic turbine regulation of the output.
- Turbulence effects of the terrain and among the units are also not considered (but a lightly varied wind speed can be used for each turbine).

Even with these limitations or especially because of them, a simple model that does not need a great number of parameters was created, as the focus was not to replace existing models that already implement these features.

This model brings together different modelling approaches, unifying continuous models, (differential equations, e.g. Equation 4) with discrete events (hourly changing mean speeds, statechart modelling within the turbines) and agent-based modelling (e.g. of the failure behaviour). The use of different paradigms allows us to create more realistic models that can take advantage of the different strengths of each approach. Flexibility is also gained as the model contemplates different points of view of the modelled system: technical, environmental influences, failure analysis, etc. The combination of different approaches is made clear for instance by using discrete events on different agents asynchronously (in contrast to continuous mathematical models) at the same time as they integrate system dynamic processes.

The agent-based approach also allows us to create a heterogeneous set of turbines, with slight variances in the parameters—even in wind speed—of the units. In this way it is possible to simulate realistic behaviour of wind farms in contrast to static, homogeneous multiplication of identical objects.

8 References

[1] C. Nichita, D. Luca, B. Dayko, E. Ceanga, Large band simulation of the wind speed for real time wind turbine

simulators, *Power Engineering Review, IEEE*, 22(8), 2002, 63-63.

[2] H. Bayem, Y. Phulpin, P. Dessante and J. Bect, Probabilistic computation of wind farm power generation based on wind turbine dynamic modeling, *10th International Conference on Probabilistic Methods Applied to Power Systems - PMAPS 2008*, Porto Rico, 2008, 1-6.

[3] R. Billinton, H. Chen and R. Ghajar, Time-series models for reliability evaluation of power systems including wind energy, *Microelectronics Reliability*, 36(9), 1996, 1253-1261.

[4] T. Allerton, *Simulating the distribution and cross-correlation of wind farm output*, (ESGI64: Heriot-Watt University, The Knowledge Transfer Network for Industrial Mathematics, The International Centre for Mathematical Sciences), 11 April 2008, Report.

[5] H. Aksoy, Z. Fuat Toprak, A. Aytek, N. Erdem nal, Stochastic generation of hourly mean wind speed data, *Elsevier - Renewable Energy*, 29(14), 2004, 2111-2131.

[6] E. Kremers, P. Viejo, Simulation of energy system scenarios for regional planning decision-making using agent-based modeling, *11th Int. Conf. on Computers in Urban Planning and Urban Management*, accepted paper, Hong Kong, 16-18 June 2009.

[7] E. Welfonder, R. Neifer, M. Spanner, Development and experimental identification of dynamic models for wind turbines, *Control Engineering Practice*, 5(1), 1997, 63-73.

[8] R. Chedid, H. Akiki and S. Rahman, A decision support technique for the design of hybrid solar-wind power systems, *IEEE transactions on Energy conversion*, 13(1), 1998, 76-83.

[9] M. Wooldridge *An Introduction to Multiagent Systems* (West Sussex, United Kingdom: John Wiley and Sons Ltd. 2009).

[10] XJ Technologies Company, St. Petersburg, Russian Federation, *Anylogic*, <http://www.xjtek.com/>, 2009.

[11] A. Denault, *Hybrid (Differential Equations - Statecharts) modeling in Anylogic*, (McGill University, Montreal, Canada, Reading Report).

[12] R. Karki, P. Hu, R. Billinton, A simplified wind power generation model for reliability evaluation, *IEEE transactions on Energy conversion*, 21(2), 2003, 533-540.