



**BILBOKO INDUSTRIA INGENIARITZA TEKNIKOKO
UNIBERTSITATE ESKOLA**



INGENIARITZA MEKANIKOKO GRADUA :

GRADU AMAIERAKO LANA

2014 / 2015

*MAÑUETAKO DOMINIO BERZAL BODEGAREN
ERAIKINA*

4 . DOKUMENTUA : PLANOAK

IKASLEAREN DATUAK

IZENA : LEIRE

ABIZENAK : CIBRIAN DELGADO

SIN. :

DATA : 2015/01/30

ZUZENDARIAREN DATUAK

IZENA : ESTEBAN

ABIZENAK : LARAUDOGOITIA ALZAGA

SAILA : INGENIARITZA MEKANIKOA

SIN. :

DATA : 2015/01/30

AURKIBIDEA

4. DOKUMENTUA: PLANOAK

4.1 Kokapen geografikoa	1Planoa
4.2. Kokalekua	2Planoa
4.3. Urbanizazioa	3Planoa
4.4 Egituraren bistak	4Planoa
4.5 Egituraren kokapena	5Planoa
4.6 Zimendapena	6Planoa
4.7 Zimendapenaren xehetasuna, 1. zapata	7Planoa
4.8 Zimendapenaren xehetasuna, 2. zapata.....	8Planoa
4.9 Zimendapenaren xehetasuna, 3. zapata.....	9Planoa
4.10 Zimendapenaren xehetasuna, 4. zapata.....	10Planoa
4.11 Zimendapenaren xehetasuna, 5. zapata.....	11Planoa
4.12 Ainguraketa plakak	12Planoa
4.13 Atzeko eta aurreko portikoa.....	13Planoa
4.14 Tarteko portikoa.....	14Planoa
4.15 Loturak.....	15Planoa
4.16 Arriostramenduak	16Planoa
4.17 Arriostramenduak (loturakI)	17Planoa
4.18 Arriostramenduk (loturak II)	18Planoa
4.19 Petralak eta kanaloiak	19Planoa
4.20 Solairuaren banaketa.....	20Planoa
4.21 Solairuaren argiztapena.....	21Planoa
4.22 Lurpeko saneamendua	22Planoa
4.23 Zurgintza.....	23Planoa

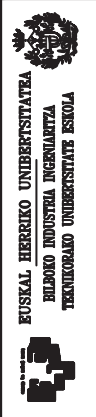
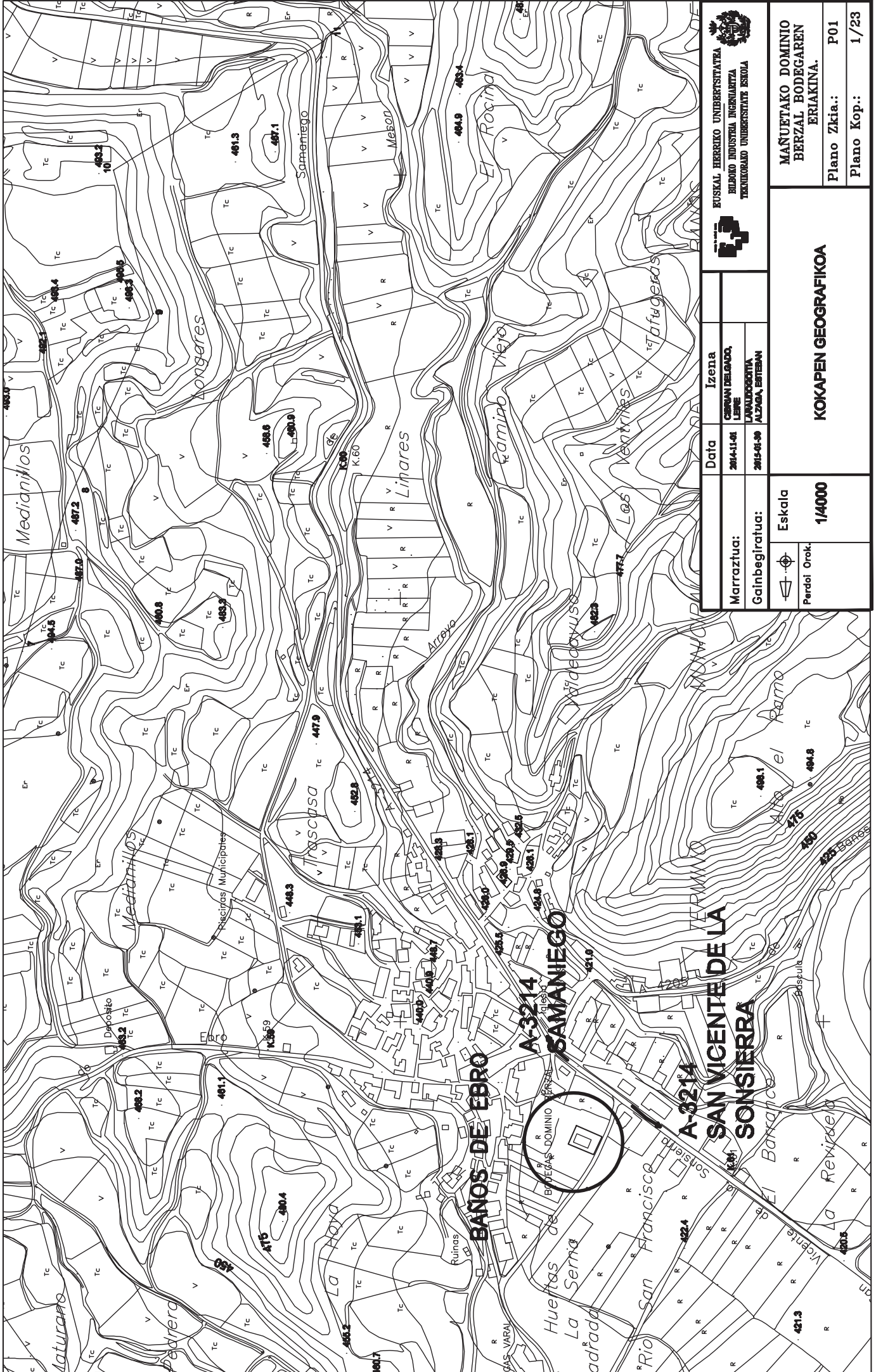

Izena	OSUAN DELGADO, LURBE
Marratzua:	2014-11-01
Gainbegiratua:	2015-01-30

MANUETAKO DOMINIO BERZAL BODEGAREN ERIAKINA.
Plano Zkia.: P01
Plano Kop.: 1/23

KOKAPEN GEOGRAFIKOA	Eskala 1/4000
MANUETAKO DOMINIO BERZAL BODEGAREN ERIAKINA.	Pardal Orak.

A-3214
BANOS DE EBRO
SAMANIEGO
A-3214
SAN VICENTE DE LA SONSIERRA



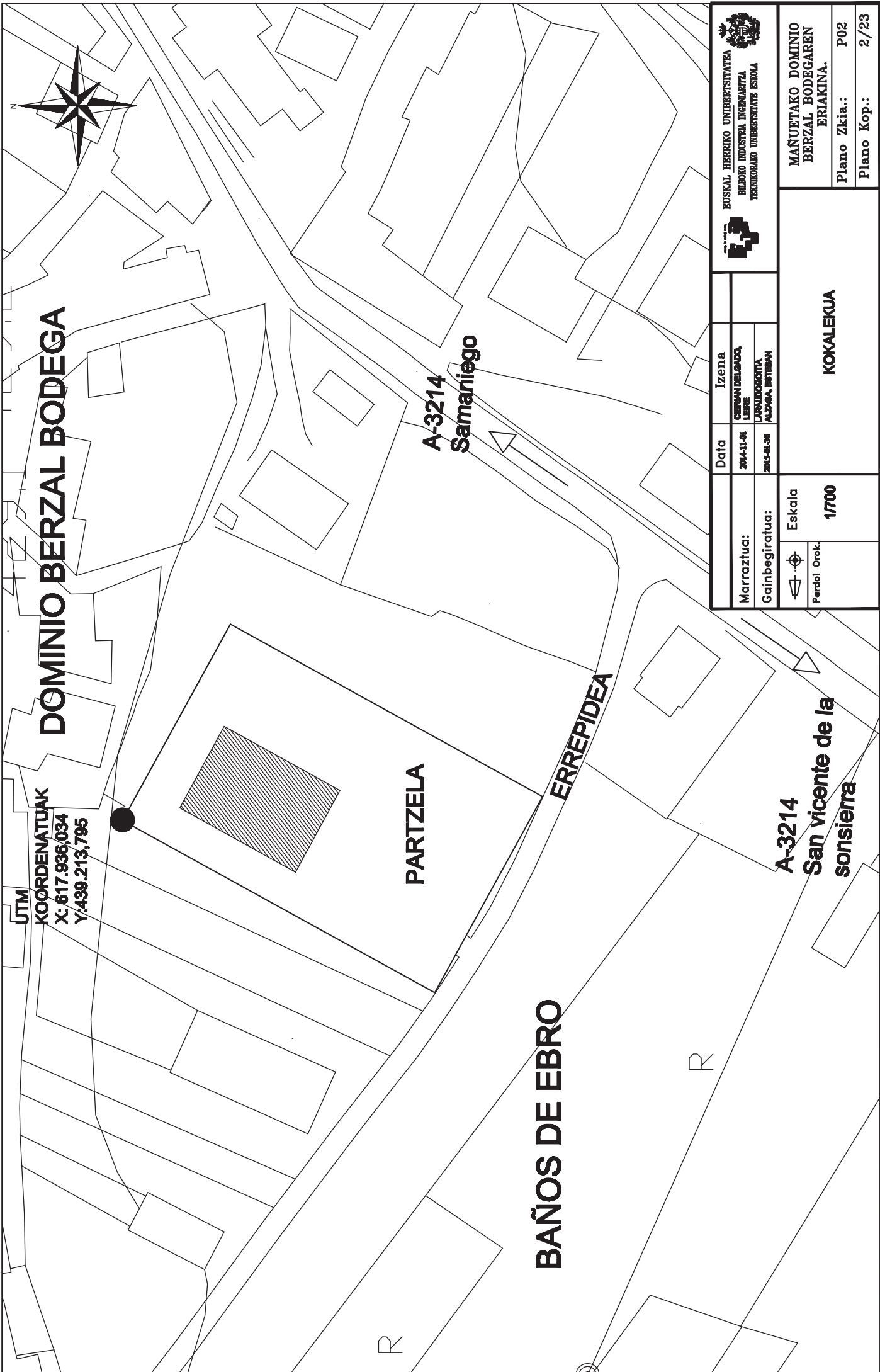

DOMINIO BERZAL BODEGA

UTM
 KOORDENATUAK
 X: 617.936,034
 Y: 439.213,795

PARTZELA

ERREPIDEA

BAÑOS DE EBRO

A-3214
 Samaniego

A-3214
 San vicente de la
 sonsierra



EUSKAL HERRIKO UNIBERTSITATEA
 ELDORO INDUSTRIA INGENIARITZA
 TEKNIKORAKO UNIBERTSITATE ESKOLA

Data	Izena
2014-11-01	CERIAN DELGADO, LERBE
Marratztua:	LARREKORTUA
Gainbegiratua:	ALZAGA, BITEBAN

Eskala	KOKALEKUA
1700	
Perdoi Orok.	

MANUETAKO DOMINIO
 BERZAL BODEGAREN
 ERIAKINA.
 Plano Zkia.: P02
 Plano Kop.: 2/23

UTM KOORDENATUAK
 X: 617.936,034
 Y: 439.213,795

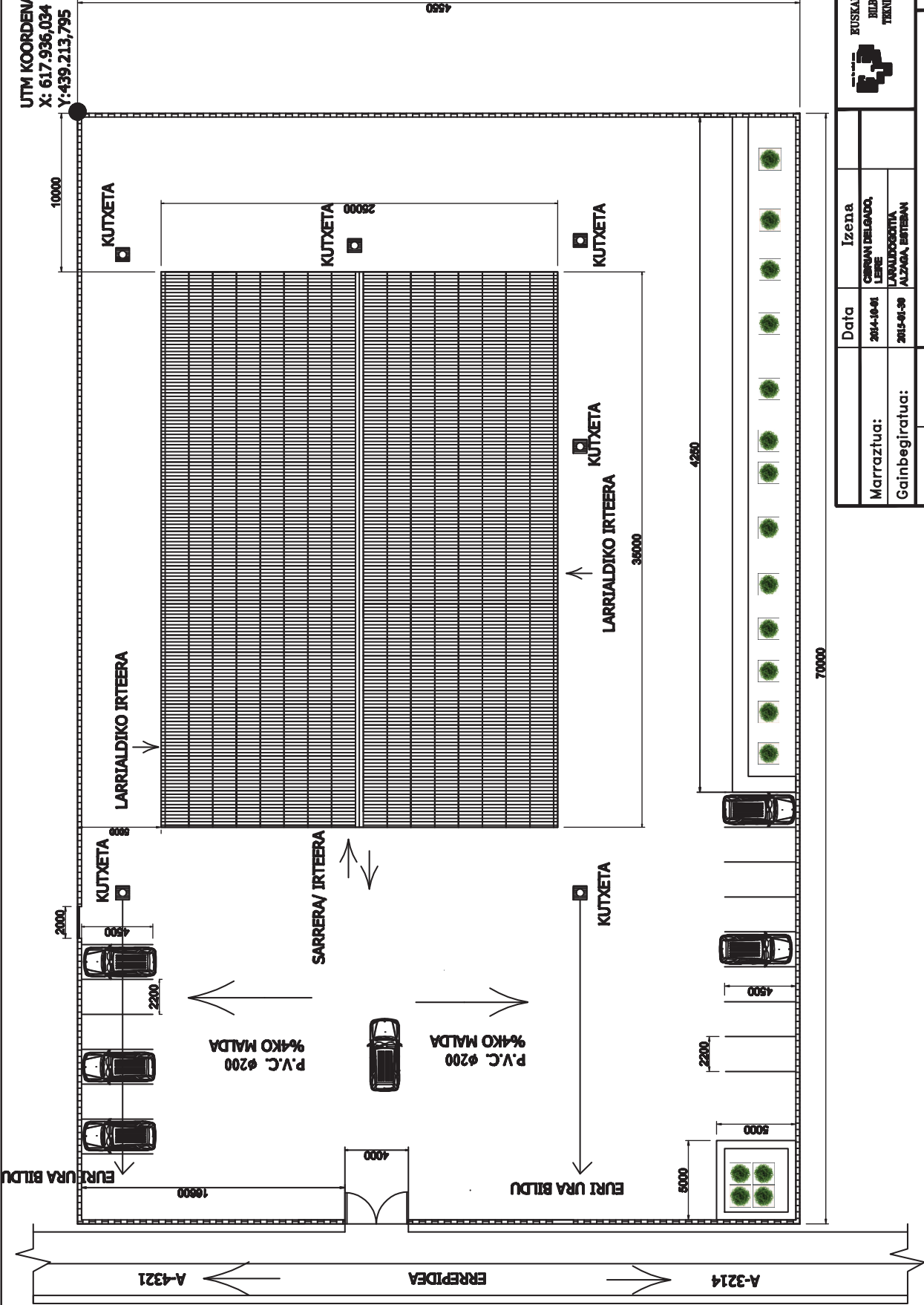

EUSKAL HERRIKO UNIBERTSITATEA
 HIBIKO INDUSTRIA INGENIARITZA
 TEKNIKORAKO UNIBERTSITATE ESKOLA

Izena	
Marrastua:	CINIAN DELGADO LEPE
Gainbegiratua:	LARUJOSOTIA ALZAGA ERTESAN

Data	
2014-10-01	
2015-01-30	

Eskala	1/250
Perdoi Orok.	

MANUETAKO DOMINIO
 BERZAL BODEGAREN
 ERIAKINA.
 Plano Zkia.: P03
 Plano Kop.: 3/23

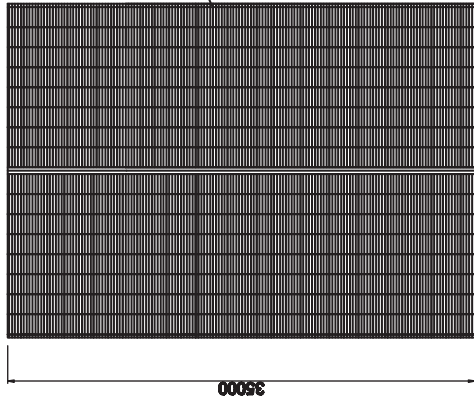
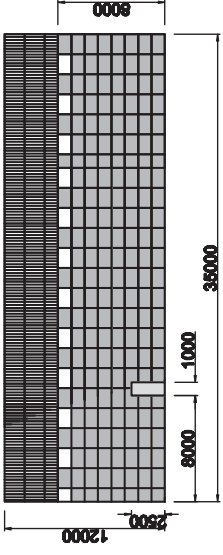
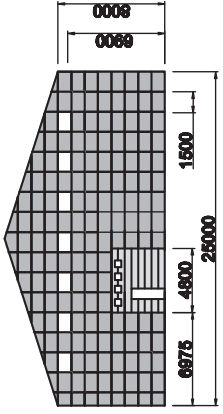
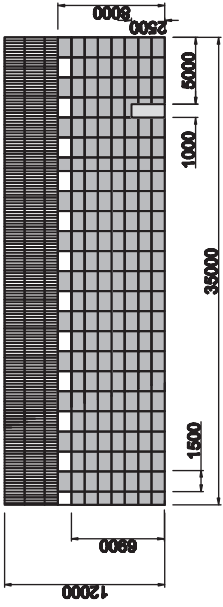

URBANIZAZIOA

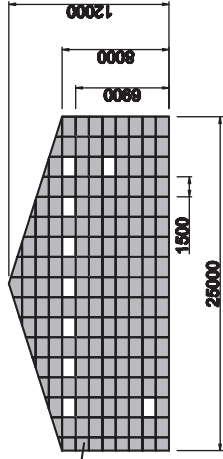

ESTALKIA ARVAL MARKAKOA, CASACAIDE 5.27.1060T





ITXITURA ALLUCOBOND A2

Marratzua:	Data	Izena	 EUSKAL HERRIKO UNIBERTSITATEA BILBOKO INDUSTRI INGENIARIATZA TEKNIKORAKO UNIBERTSITATE ESKOLA
	2014-11-01	CIBRIAN DELGADO, LEIRE	
Gainbegiratua:	2015-01-30	LARAUDEGONTIA ALZAGA ESTEBAN	
 Eskala  Perdoi Orok.	Egituraren Bistak		MAÑUTAKO DOMINIO BERZAL BODEGAREN ERIAKINA.
	1/400		

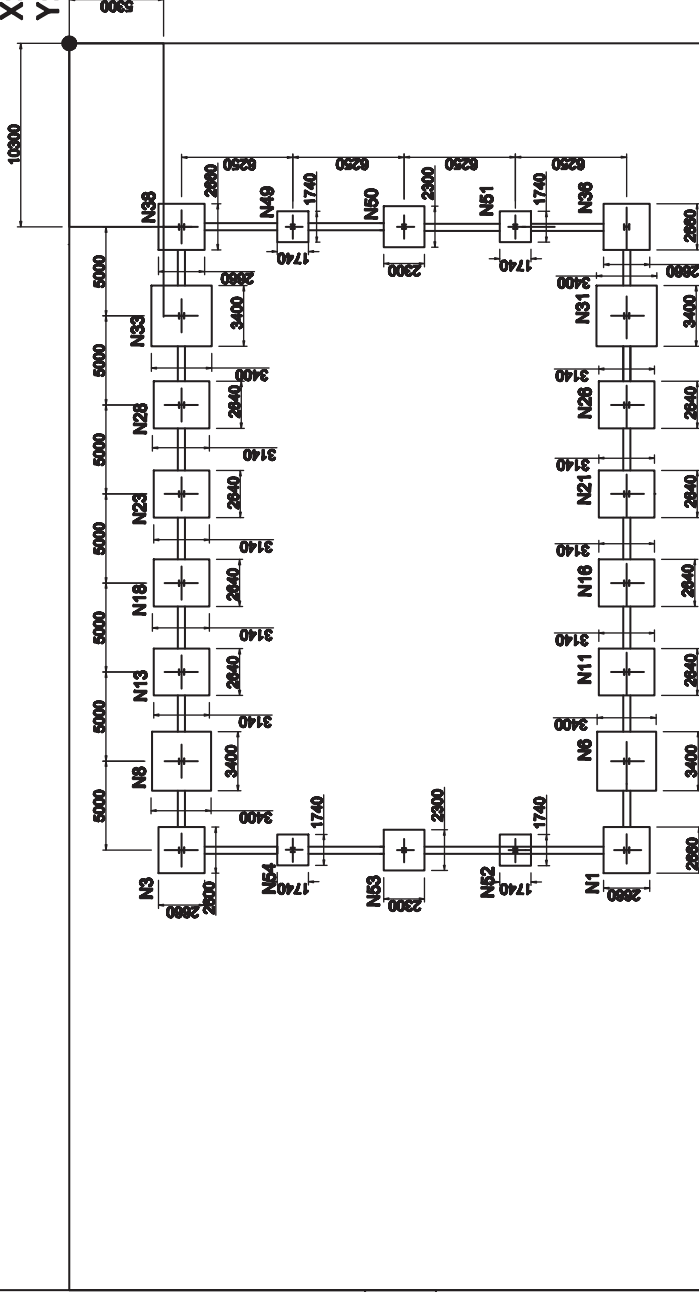
UTM KOORDENATUAK
 X: 617.936,034
 Y: 439.213,795



A-3214 ERREPIDEA

Marratzitua:	Data		Izena
	2014-10-01	2014-10-01	
Gainbegiratua:	2015-01-30		ALZAGA, ESTEBAN
 Perdoi Orok.	Eskala		EGITURAREN KOKAPENA
	1/300		
 EUSKAL HERRIKO UNIBERTSITATEA BIHOKO INDUSTRIA INGENIARITZA TEKNIKORAKO UNIBERTSITATE ESKOLA			MAÑUTAKO DOMINIO BERZAL BODEGAREN ERIAKINA. Plano Zkia.: P05 Plano Kop.: 5/23

1.ZAPATA

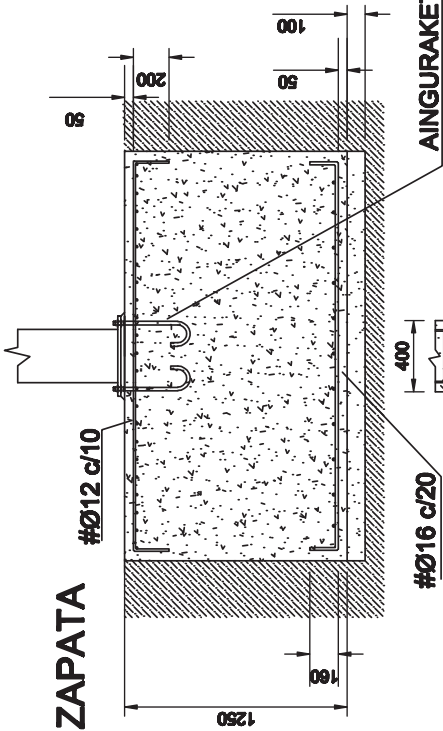

AINGURAKETA BERNOAK

#Ø16 c/20

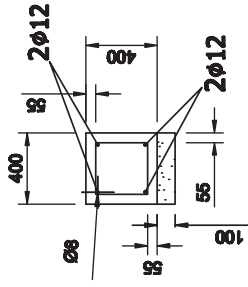

GARBIKETA HORMIGOIA HL-150

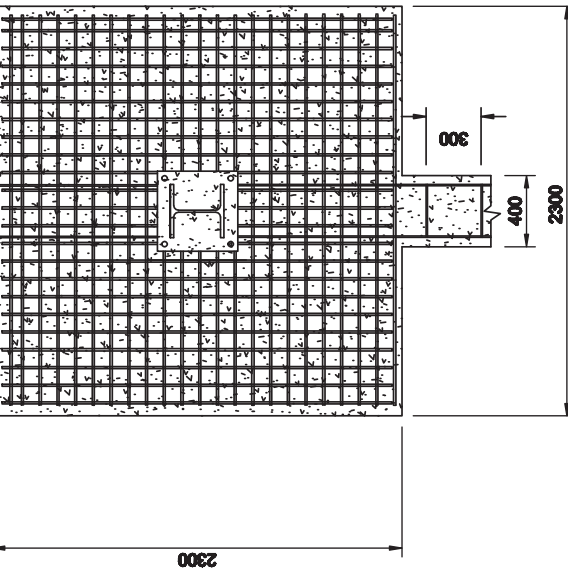
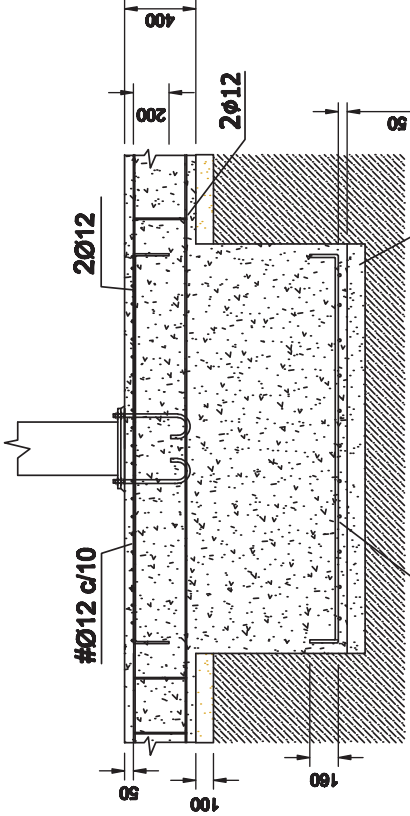

ZIMENDAPENEGO ZAPATA SINTPLEEN TAULA

ZAPATA AINGURA PLAKA	ZUTABEAK	DIMEN. (MM)	SAKON. BEHE ARM.GOHI ARM. -X-, -Y-	Ø16 C/20	Ø12 C/10
1	3	N53, N50	2300X2300	1250	Ø12 C/10

AINGURAKETA PERNO XEHETASUNA

AZKOINA ISO 4328 M-20

Oinarri plaka

Orekatze morteroa

Pernoø Ø20mm B400 S Ys =1,15

Hormigoia: HA-25 Y=15

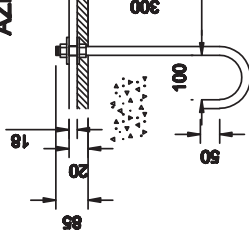

AINGURAKETA PLAKAREN ZENTRURA ORIENTATUTA

ZAPATA MOTA	POB.	DIAM.	KOP.	HANK. (cm)	ZUZENA (cm)	HANK. (cm)	LUZE. (cm)	GUZTIRA (cm)	B400YS= 1.15
1	Ø12	22	20	259	20	259	11.160	11.160	14.5
2	Ø16	11	16	259	16	259	5.862	5.862	14.5
3	Ø12	22	20	259	20	259	11.160	11.160	14.5
4	Ø16	11	16	259	16	259	5.862	5.862	14.5
Tot. *%10:									63.8
X2:									127.6

EUSKAL HERRIKO UNIBERTSITATEA HIBROKO INDUSTRIA INGENIARITZA TEKNIKORAKO UNIBERTSITATE ESKOLA		EUSKAL HERRIKO UNIBERTSITATEA HIBROKO INDUSTRIA INGENIARITZA TEKNIKORAKO UNIBERTSITATE ESKOLA	
Data:		Izena:	
Marraztua:		CIBRAN DELGADO, LEIRE	
Gai-begiratua:		LABURDOROTIA ALZAGA, ESTEBAN	
Eskala:		ZIMENDAPENAREN XEHETASUNA 1. ZAPATA	
Perdoi. Orek.:		MAÑUETAKO DOMINIO BERZAL BODEGAREN ERIAKINA.	
1/30 1/14		Plano Zkia.: P07 Plano Kop.: 7/23	

3.ZAPATA

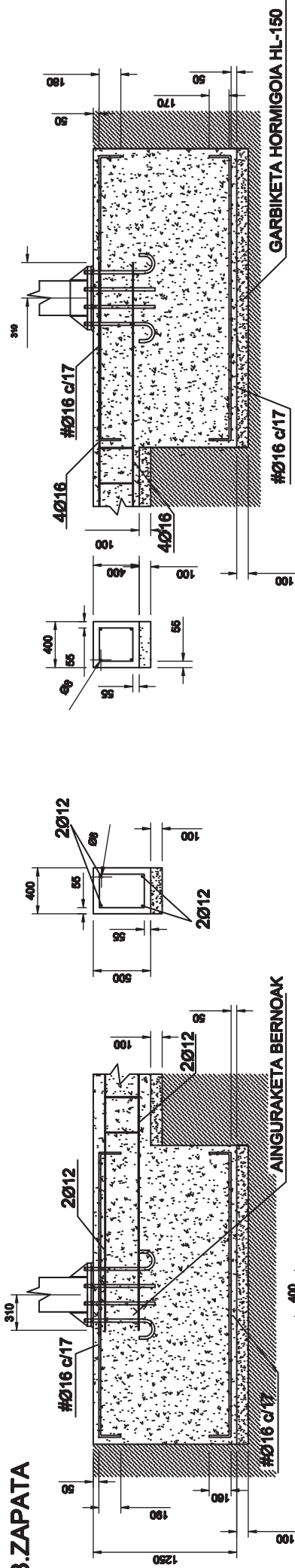

ANGURAKETA PERNO XEHETASUNA

AZKOINA ISO 4328 M-20

Oinarri plaka

Orekaize morteroa

Perno Ø25mm B400 S $\gamma_s = 1,15$

Hormigoia: HA-25 $\gamma = 15$

ANGURAKETA PLAKAREN ZENTRURA ORIENTATUTA

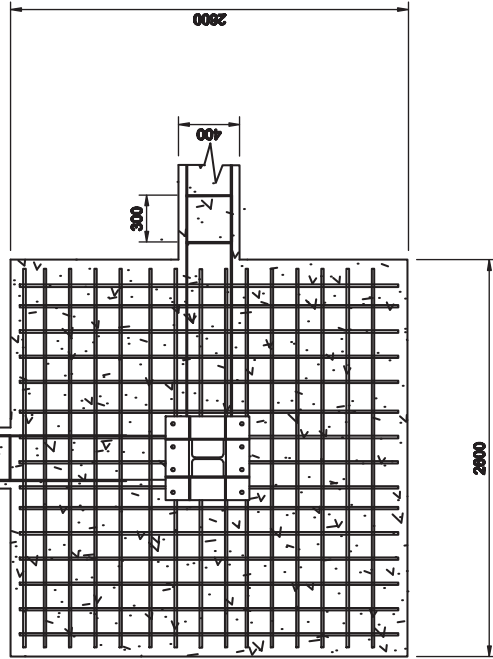

ZAPATA MOTA	POS.	DIAM.	KOP.	HANK.(cm)	ZUZE.(cm)	HAN.(cm)	LUZE.(cm)	GUZTIRA(cm)	B 400 $\gamma_s = 1.15$
3	1	Ø16	15	19	286	19	286	9.150	15.9
	2	Ø16	15	16	280	16	280	8.880	15.9
	3	Ø16	15	19	286	19	286	9.150	15.9
	4	Ø16	15	16	280	16	280	8.880	15.9
								tot. +%10:	69.96
								X2:	139.92

ZIMENDAPENENKO ZAPATA SINPLEEN TAULA

ZAPATA PLAKA	ANGURA	ZUTABE.	DIMEN. (mm)	SAKON. (mm)	BEHE ARM. -X-, -Y-	GOHI ARM. -X-, -Y-
3	1	N1, N3, N38, N36	2800x2800	1250	Ø16 C/17	Ø16 C/17

Data		Izena	
Marratzua:	2014-10-01	CIBRIAN DELGADO, LEIRE	
Gainbegiratua:	2015-01-30	LARALDOGOTIA, ALZAGA, ESTEBAN	



ZIMENDAPENAREN XEHETASUNA
3.ZAPATA

Eskala

1/35

Perdoi Orok.

1/15

MANUETAKO DOMINIO
BERZAL, BODEGAREN
ERIAKINA.

Plano Zkia.: P09

Plano Kop.: 9/23

4.ZAPATA

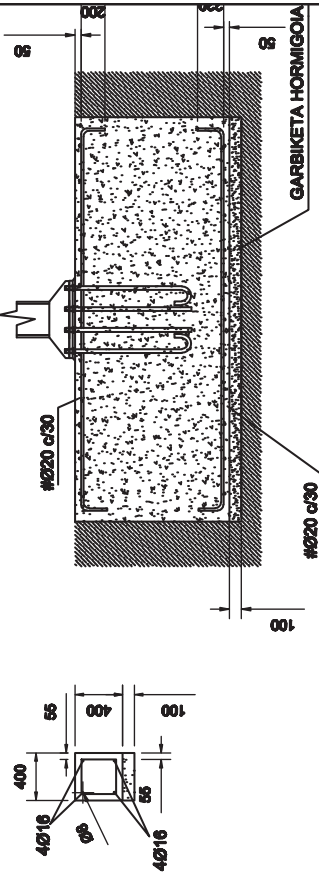
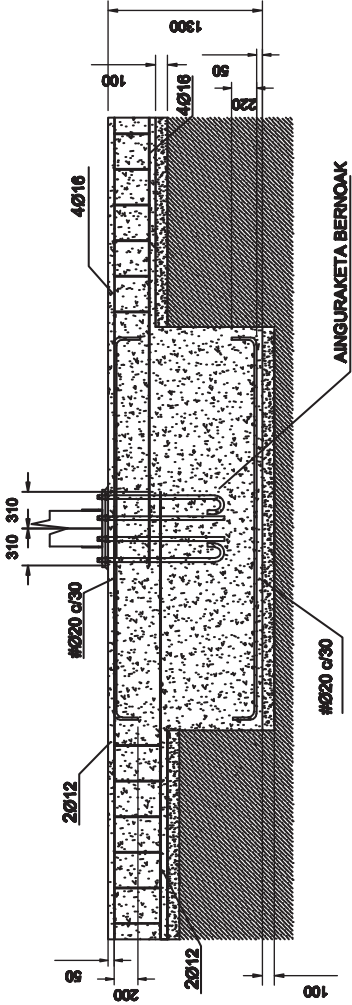
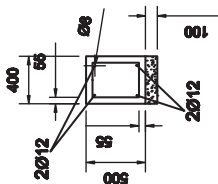

ANGURAKETA PERNO XEHETASUNA
AZKOINA ISOX 4328 M-20

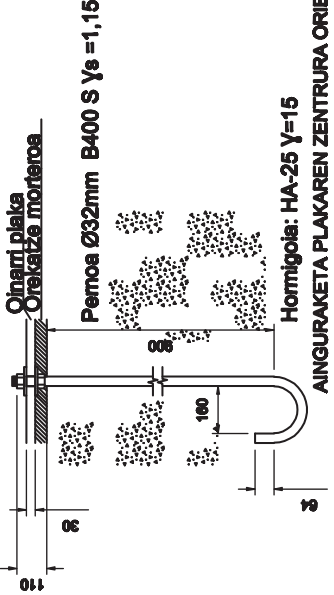

ANGURAKETA PLAKAREN ZENTRURORA ORIENTATUTA

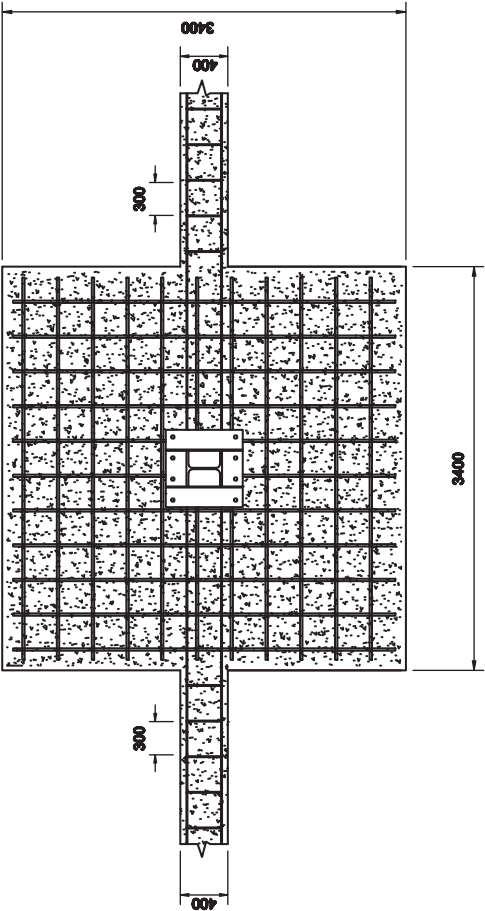

ZAPATA MOTA	POS.	DIAM.	KOP.	HANK.(cm)	ZUZEN.(cm)	HANK.(cm)	LUZE.(cm)	GUZTIRA(cm)	B 400 Ys= 1,15
4	1	Ø20	11	20	360	20	360	6.360	20,5
	2	Ø20	11	20	360	20	360	6.360	20,5
	3	Ø20	11	20	360	20	360	6.360	20,5
	4	Ø20	11	20	360	20	360	6.360	20,5
								Tot. +/-10:	90,2
								X2:	360,8

ZIMENDAPENeko ZAPATA SINPLEEN TAULA

ZAPATA	ANGURA PLAKA	ZUTABE DIMENTSI. (MM)	SAKON. (MM)	BEHE ARM. -X-, -Y-	GOHI ARM. -X-, -Y-
4	2	N6, N8, N31, N33	3400X3400	Ø20 C/30	Ø20 C/30



Data	Izena
2014-10-01	CIBRIAN DELGADO, LEIRE
2015-01-30	LARAUZOGOTIA ALZAGA, ERTEBAN

ZIMENDAPENAREN XEHETASUNA 4.ZAPATA	
Eskala	MAÑUTAKO DOMINIO BERZAL BODEGAREN ERIAKINA.
Perdoi Orok.	Plano Zkia.: P10
	Plano Kop.: 10/23

5.ZAPATA

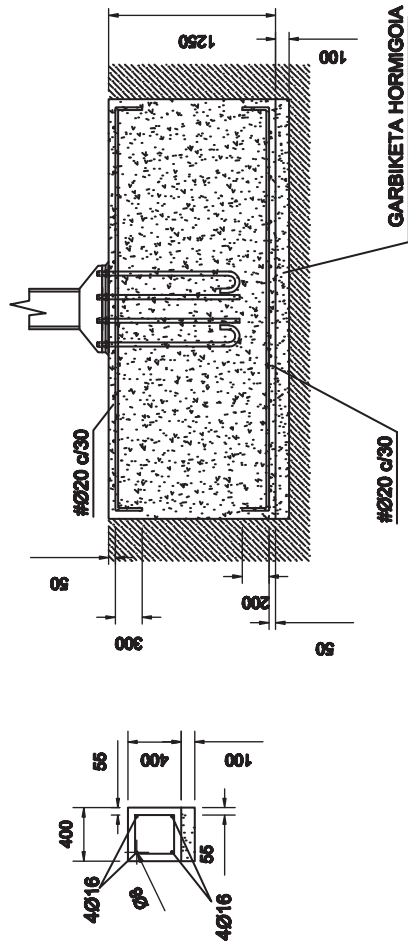

AINGURAKETA PERNO XEHETASUNA
AZKOINA ISOX 4328 M-20

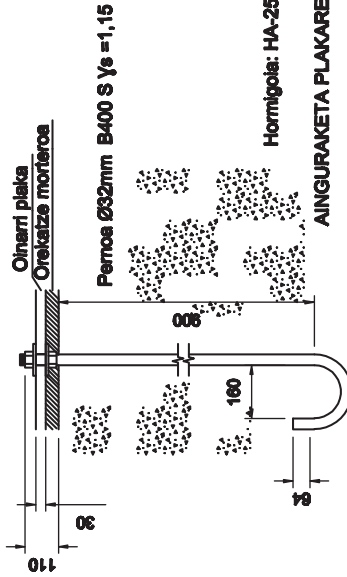
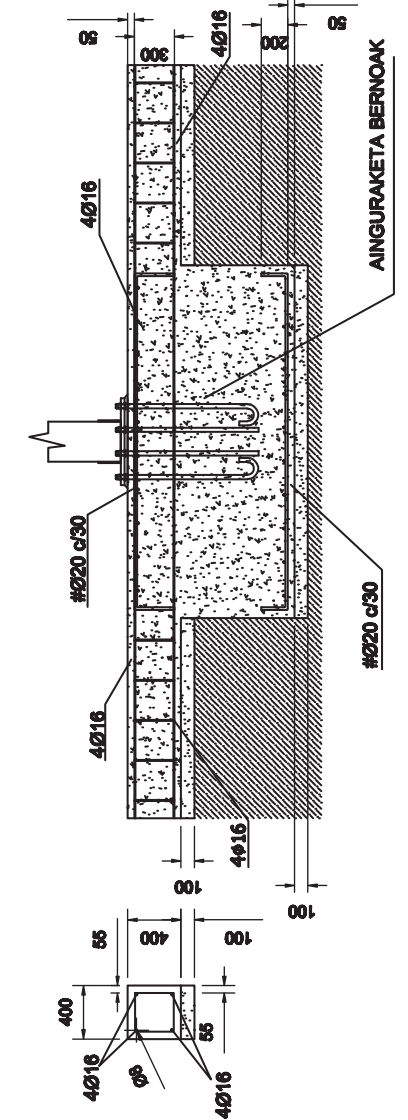

AINGURAKETA PLAKAREN ZENTZURA ORIENTATUTA

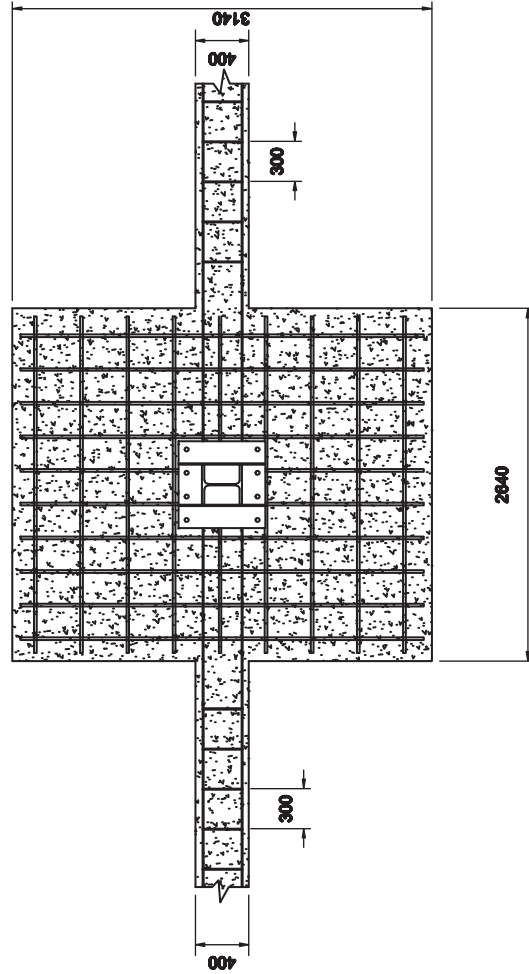

ZAPATA MOTA	POS.	DIAM.	KOP.	HANK.(cm)	ZUZENA(cm)	HANK.(cm)	LUZE.(cm)	GUZTIRA(cm)	B 400 Ys= 1.15
5	1	Ø20	10	30	312	30	312	6940	18.9
	2	Ø20	10	20	292	20	292	6240	18.9
	3	Ø20	10	30	312	30	312	6940	18.9
	4	Ø20	10	20	292	20	292	6240	18.9
Tol. +%-10:									83.16
X7:									562.12

<p>EUSKAL HERRIKO UNIBERTSITATEA BILBOKO INDUSTRI INGENIARTZA TEKNIKORAKO UNIBERTSITATE ESKOLA</p>		<p>Izena</p>	
<p>Marrazitua:</p>		<p>2014-10-01</p>	
<p>Gainbegiratua:</p>		<p>2015-01-30</p>	
<p>Eskala</p>		<p>ZIMENDAPENAREN XEHETASUNA</p>	
<p>Perdoi Orok:</p>		<p>5.ZAPATA</p>	
<p>1/40</p>		<p>MAÑUFAKO DOMINIO BERZAL BODEGAREN ERIAKINA.</p>	
<p>1/16</p>		<p>Plano Zkia.: P.11</p>	
<p></p>		<p>Plano Kop.: 11/23</p>	

ZIMENDAPENENKO ZAPATA SINPLEEN TAJULA			
ZAPATA AINGURA PLAKA	ZUTABEAK	DIMEN. SAKON, BEHE ARM. (MM)	GOHI ARM. -X-, -Y-
5	2	N11, N13, N16, N18, N21, N23, N26, N28	Ø20 C/30
		2640x3140	Ø20 C/30
		1250	Ø20 C/30

I.MOTA

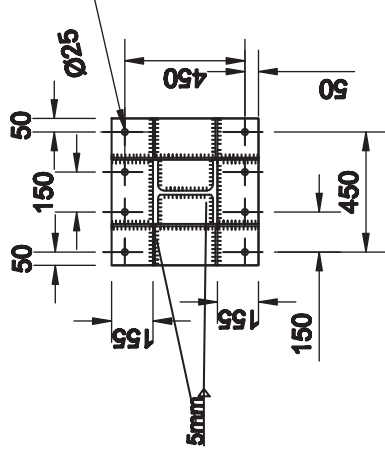
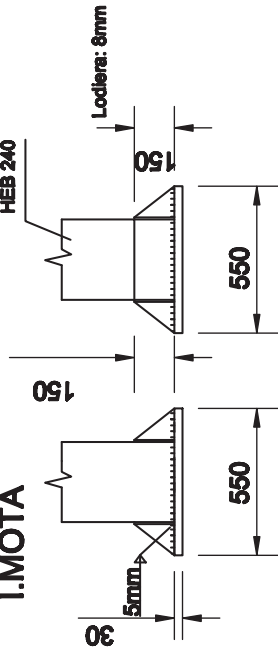

II.MOTA

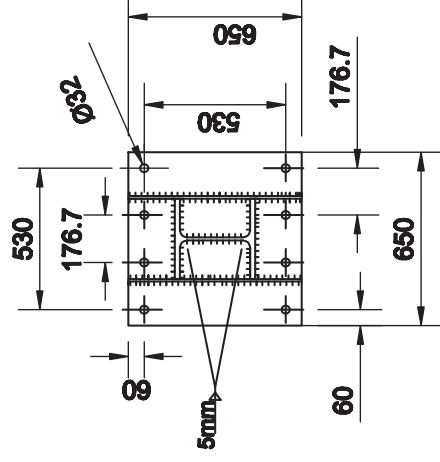
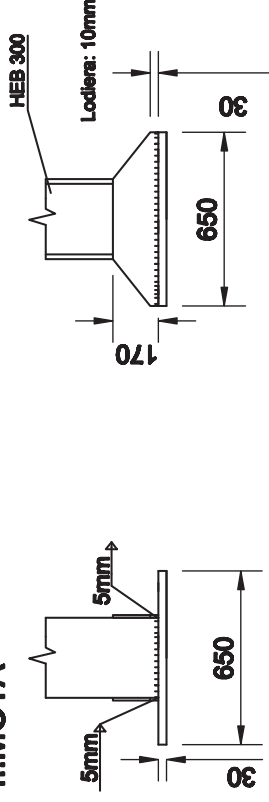

III.MOTA

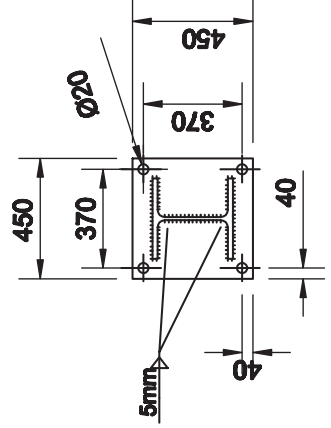
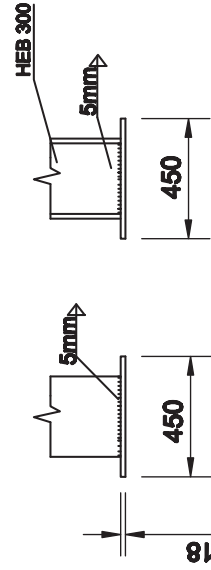

Izendapena	Erreferentzia	Permoak	Ainguraketa plaken dimentsioak
I. Mota	N1, N3, N36, N38	8Ø25mm L=45cm	550 X 550 X 30 (mm)
II.Mota	N6, N11, N16, 21, N26, N31, N13, N18, N23, N28, N33	8Ø32mm L=90cm	650 X 650 X 30 (mm)
III.Mota	N49, N50, N51, N52, N53, N54	4Ø20mm L=30cm	450 x 450 x 18(mm)

Eskala		Izena	
Perdoi Orok.		CIBRIAN DELGADO, LEIRE	
1/20		LARRUGOSIONIA ALZAGA, ESTEBAN	
Gainbegiratua:		Data	
		2014-10-01	
		2015-01-30	
		Marratzua:	
		EUSKAL HERRIKO UNIBERTSITATEA	
		BILBOKO INDUSTRIA INGENIARIATZA	
		TEKNIKORAKO UNIBERTSITATEBESKOLA	
		AINGURAKETA PLAKAK	
		MAÑUETAKO DOMINIO	
		BERZAL BODEGAREN	
		ERIAKINA.	
		Plano Zkia.: P12	
		Plano Kop.: 12/23	

MATERIAL ALTZAIRU S275 JR

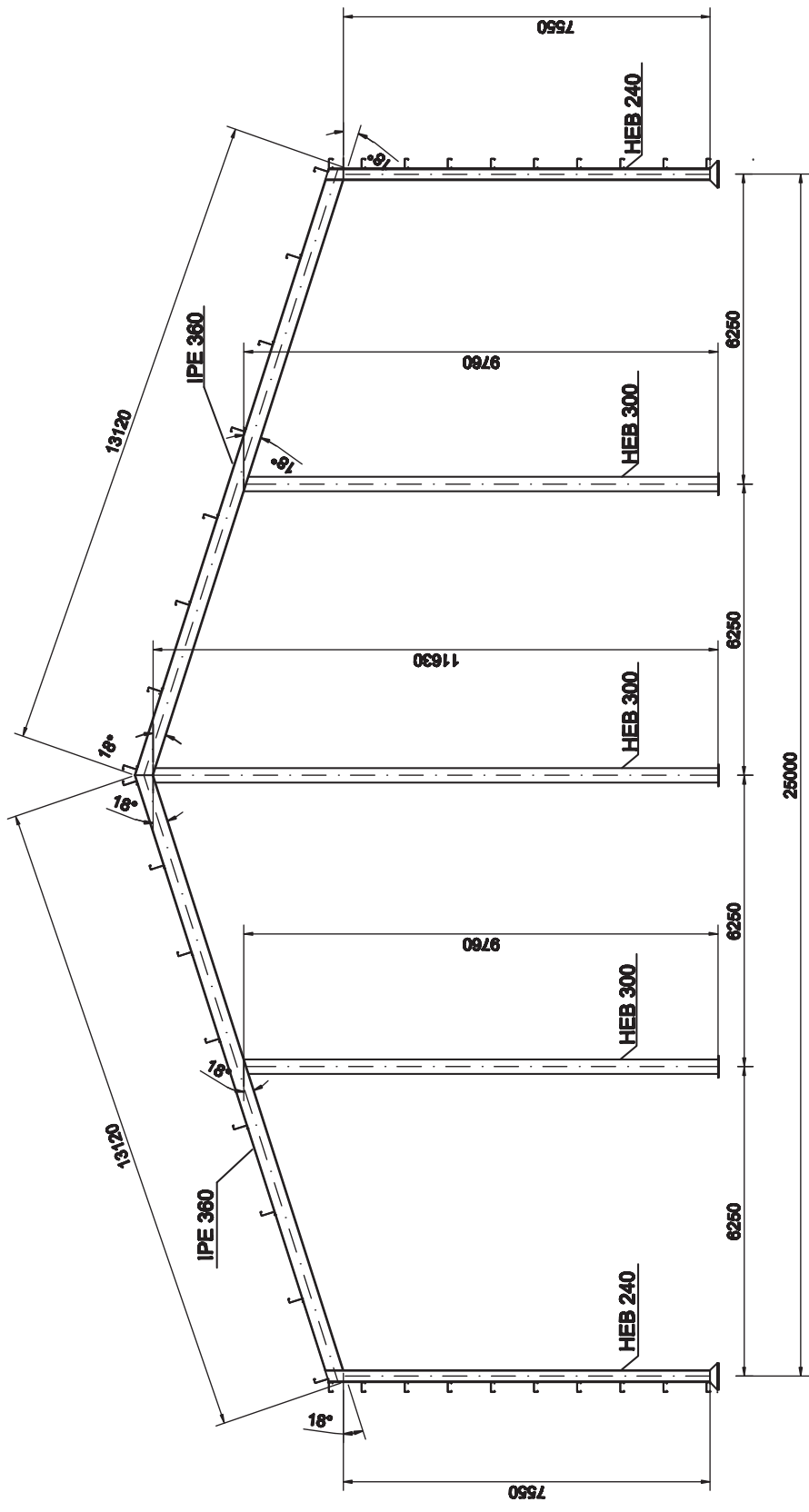

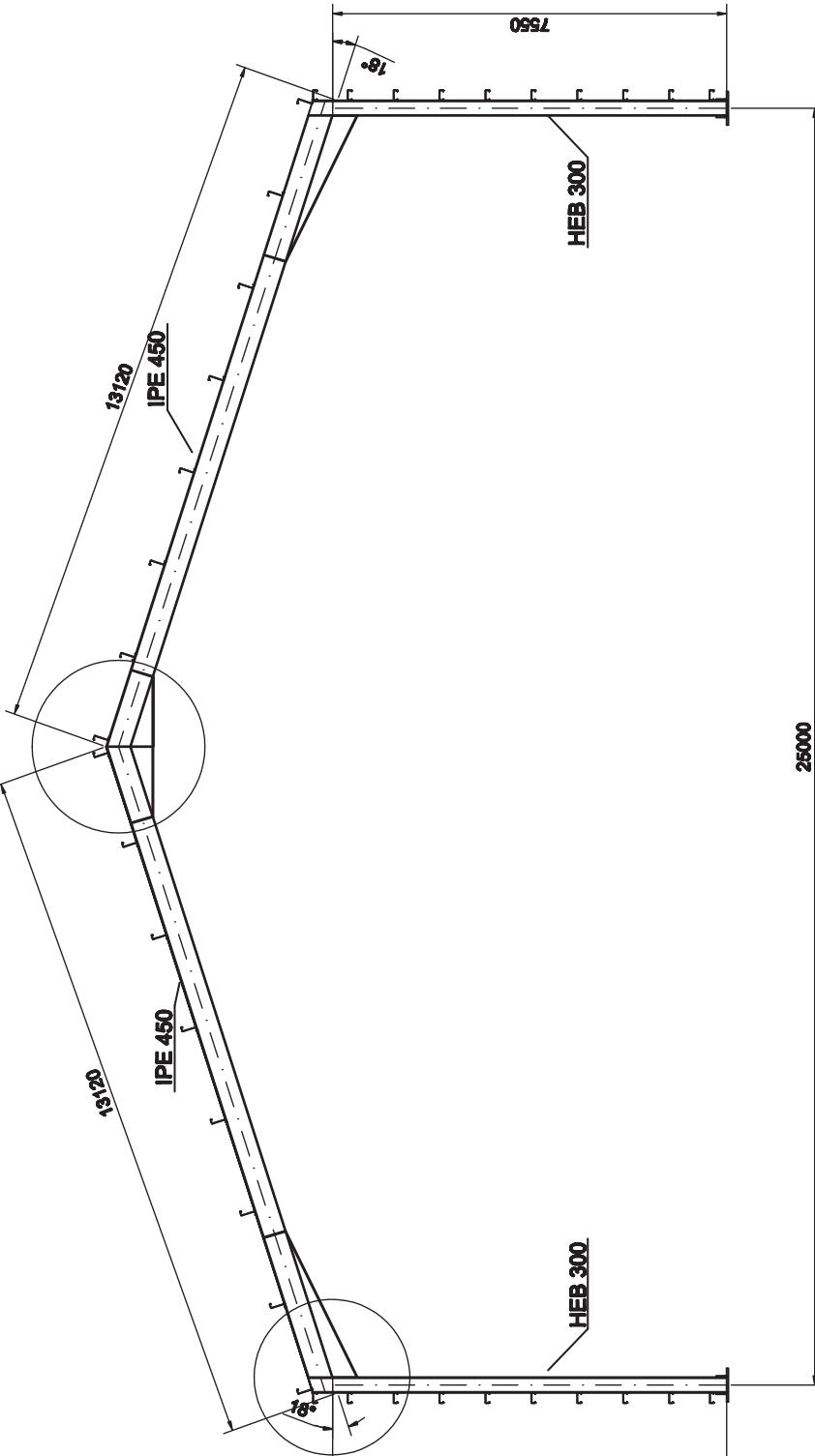

Marrastua:	Izena		EUSKAL HERRIKO UNIBERTSITATEA BIBOIO INDUSTRIA INGENIARITZA TEKNIKORAKO UNIBERTSITATE ESKOLA
	Data	Izena	
Gainbegiratua:	2014-10-01	CIBRIAN DELGADO, LEIRE	
	2015-01-30	LARAUZOSAITIA ALZAGA, ERTEBAN	
Perdoi Orok.	Eskala		ATZEKO ETA AURRETIKO PORTIKOA MAÑUETAKO DOMINIO BERZAL BODEGAREN ERIAKINA. Plano Zkia.: P13 Plano Kop.: 13/23
	1/100		

I. Xehetasuna
(Plano zkia: 15)



II. Xehetasuna
(Plano zkia: 15)

 EUSKAL HERRIKO UNIBERTSITATEA BILBOKO INDUSTRIAL INGENIARITZA TEKNIKORAKO UNIBERTSITATE ESKOLA		 MAÑUTAKO DOMINIO BERZAL BODEGAREN ERIAKINA.	
Marraztua: 2014-10-01 GIBRIAN DELGADO, LEIRE		Izena 2015-01-30 LARRODGOITIA ALZAGA, ESTEBAN	
Gainbegiratua:  Perdol Orok.		Eskala 1/100	
TARTEKO PORTIKOAK			
Plano Zkia.: P14		Plano Kop.: 14/23	

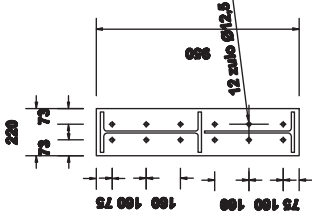
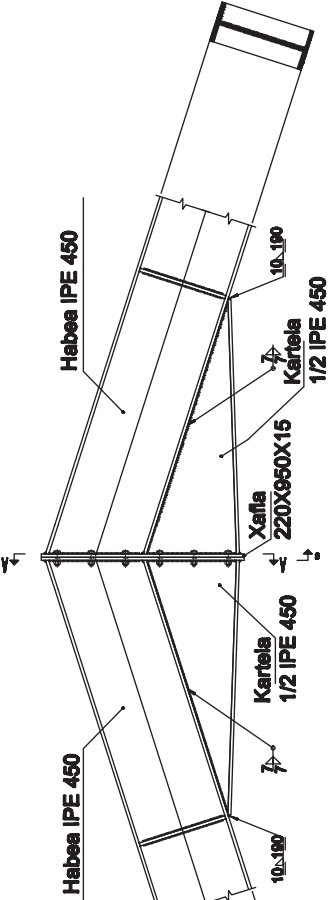
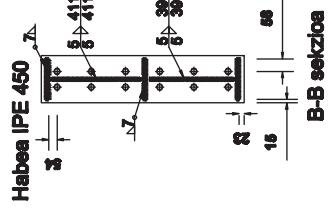
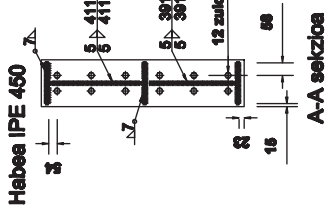
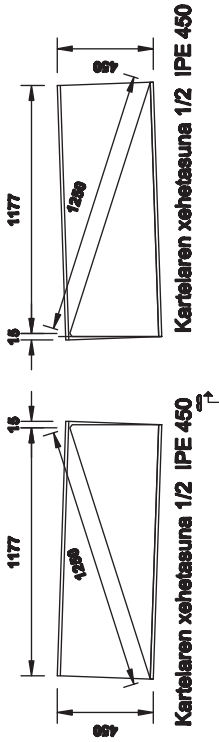

I.XEHETASUNA

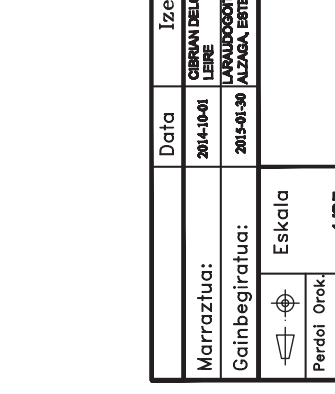
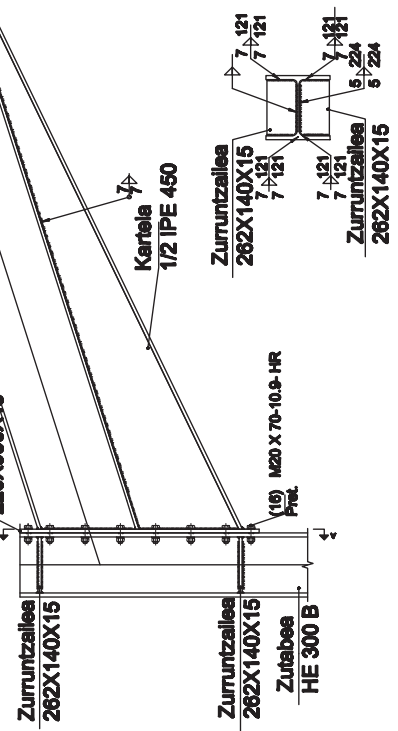
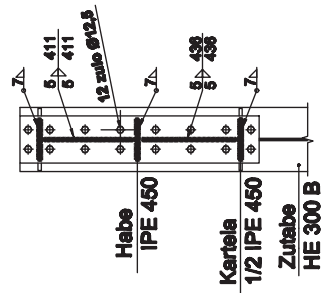

Aurrealdeko xafiak (e=15mm)

II.XEHETASUNA



 EUSKAL HERRIKO UNIBERTSITATEA BIBORO INDUSTRIA INGENIARITZA TEKNIKORAKO UNIBERTSITATE ESKOLA		 MANUELTAKO DOMINIO BERZAL BODEGAREN ERIAKINA.	
Data 2014-10-01 2015-01-30		Izena GIBRIAN DELGADO, LEIRE LARAUDOSOTTA ALZAGA, ESTEBAN	
Marraztua: Eskala Perdoi Orok.		LOTURAK 1/25	
Gainbegiratua: Eskala Perdoi Orok.		Plano Zkia.: P15 Plano Kop.: 15/23	

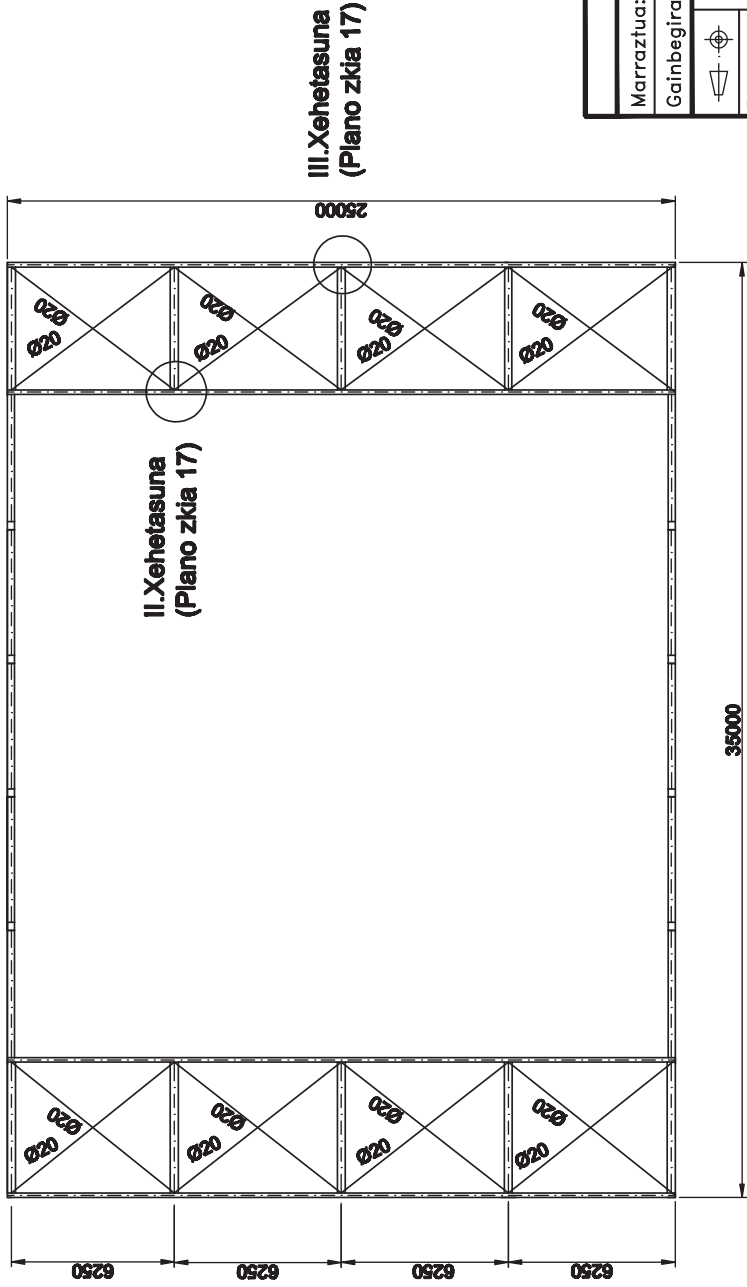
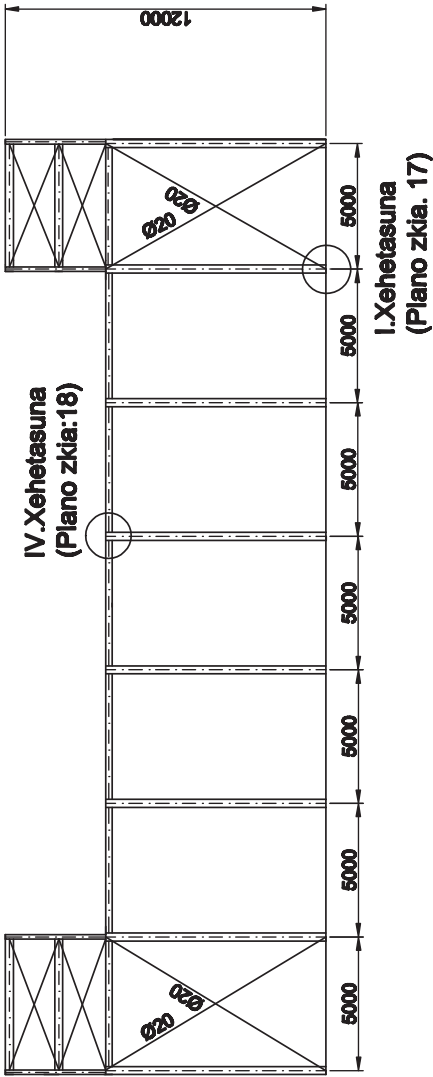

I.Xehetasuna
(Plano zkia. 17)

II.Xehetasuna
(Plano zkia 17)

Marratzua: 2014-10-01	Izena CURSAN DEL GADO, LEIRE	Eskala 1/200	MAÑUTAKO DOMINIO BERZAL BODEGAREN ERIAKINA.	EUSKAL HERRIKO UNIBERTSITATEA BILBOKO INDUSTRIA INGENIARITZA TEKNIKORAKO UNIBERTSITATE ESKOLA
2013-01-30	LARRAUSOLOKITA ALZAGA, ESTEBAN		ARRIOSTRAMENDUAK	
				P16
				16/23

IV. XEHETASUNA

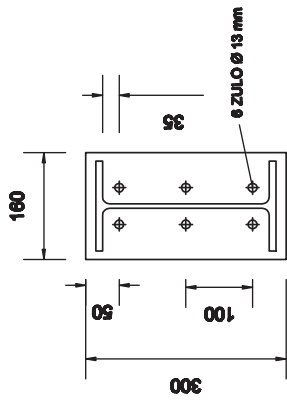

IPÉ 270 HABEAREN XAFLA FRONTALA
($\phi = 11\text{mm}$)

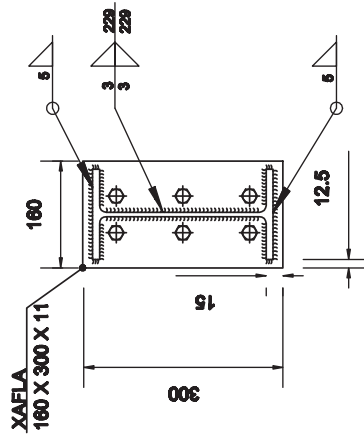

SOLDADURAREN XEHETASUNA: IPE
HABEA

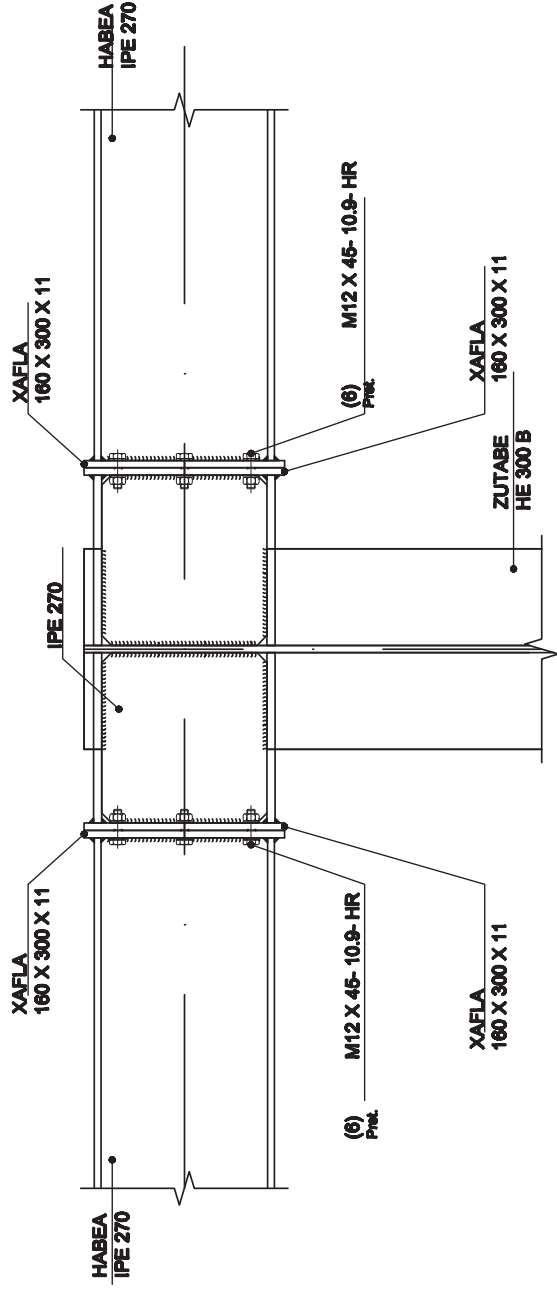

Marratzua:	Izena	
	2014-10-01	CIBRIAN DELGADO, LEIRE
Gainbegiratua:	2015-01-30	LARROUSQUITA, ALZABIA, ESTEBAN
Eskala	ARRIOSTRAMENDUAK (LOTURAK II)	
	1/8	
Perdoi Orok.	P18	
Plano Kop.:	18/23	

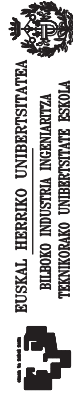

MANUETAKO DOMINIO
BERZAL BODEGAREN
ERIAKINA.

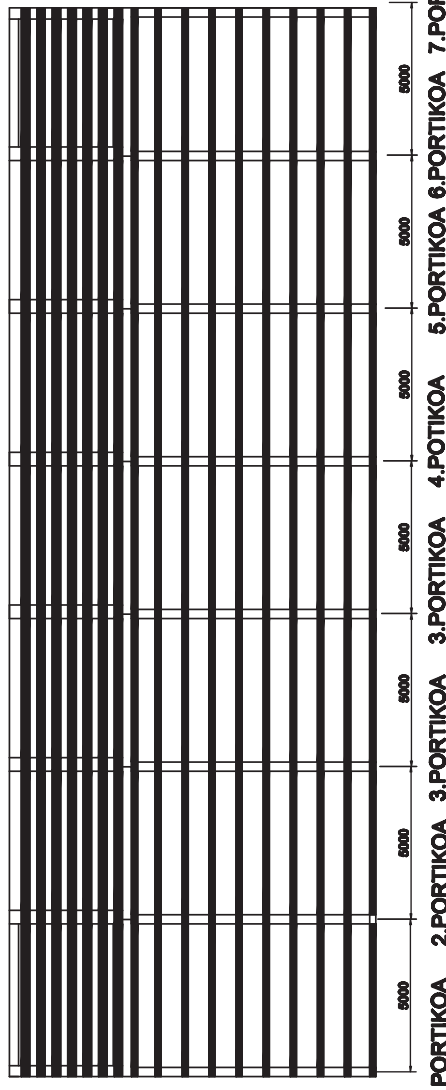
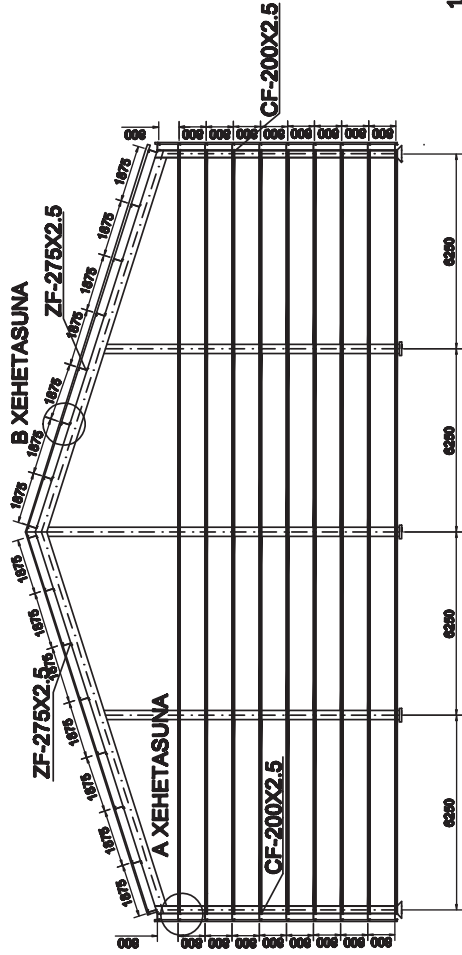

1. PORTIKOIA 2.PORTIKOIA 3.PORTIKOIA 3.PORTIKOIA 4.POTIKOIA 5.PORTIKOIA 6.PORTIKOIA 7.PORTIKOIA

A XEHETASUNA

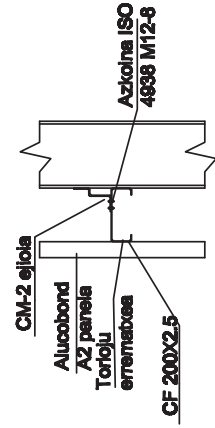

B XEHETASUNA

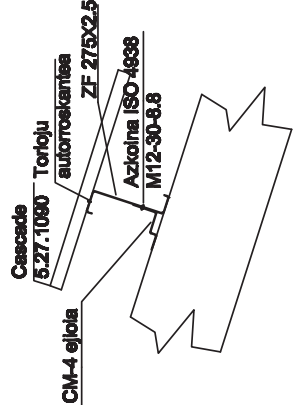

EJIOIA CM-2

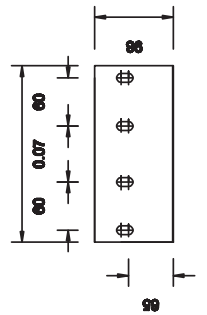



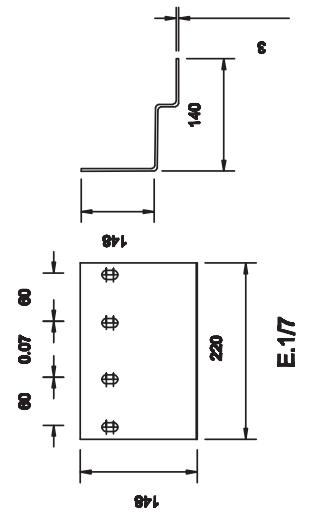

EJIOIA CM-4

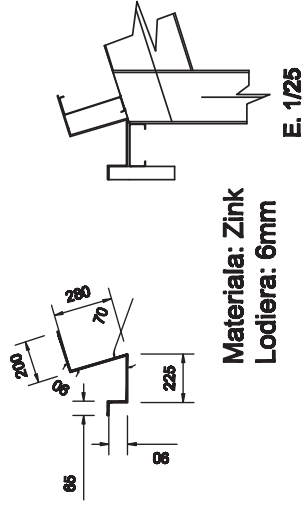

KANALIOIAREN XEHETASUNA



**Materia: Zink
Lodiera: 6mm**

 EUSKAL HERRIKO UNIBERTSITATEA BILKOKO INDUSTRIA INGENIARITZA TEKNIKOKO UNIBERTSITATE ESKOLA		 MAÑUTAKO DOMINIO BERZAL BODEGAREN ERIAKINA.	
Marratzua:	2014-10-01	Izena:	CIBRIAN DELGADO, LEIRE
Gainbegiratua:	2015-01-30	Gainbegiratua:	KANALIOGOTIA ALZAGA, ESTEBAN
 Escala  Perdai Orok:		PETRALAK ETA KANALIOIAK	
1/175		Plano Zkia: P19 Plano Kop.: 19/23	



E. 1/150

ATE NAGUSIAREN XEHETASUNA

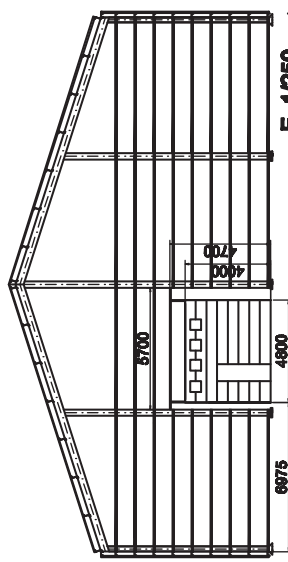

E. 1/250

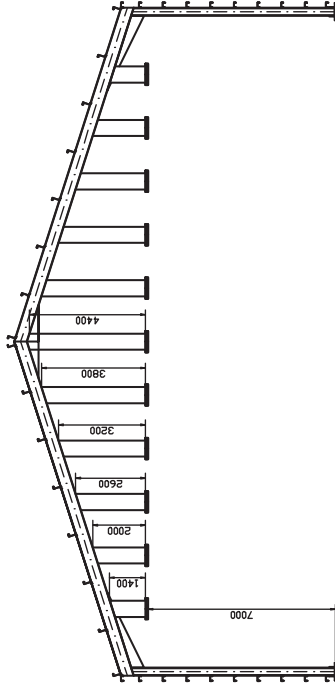
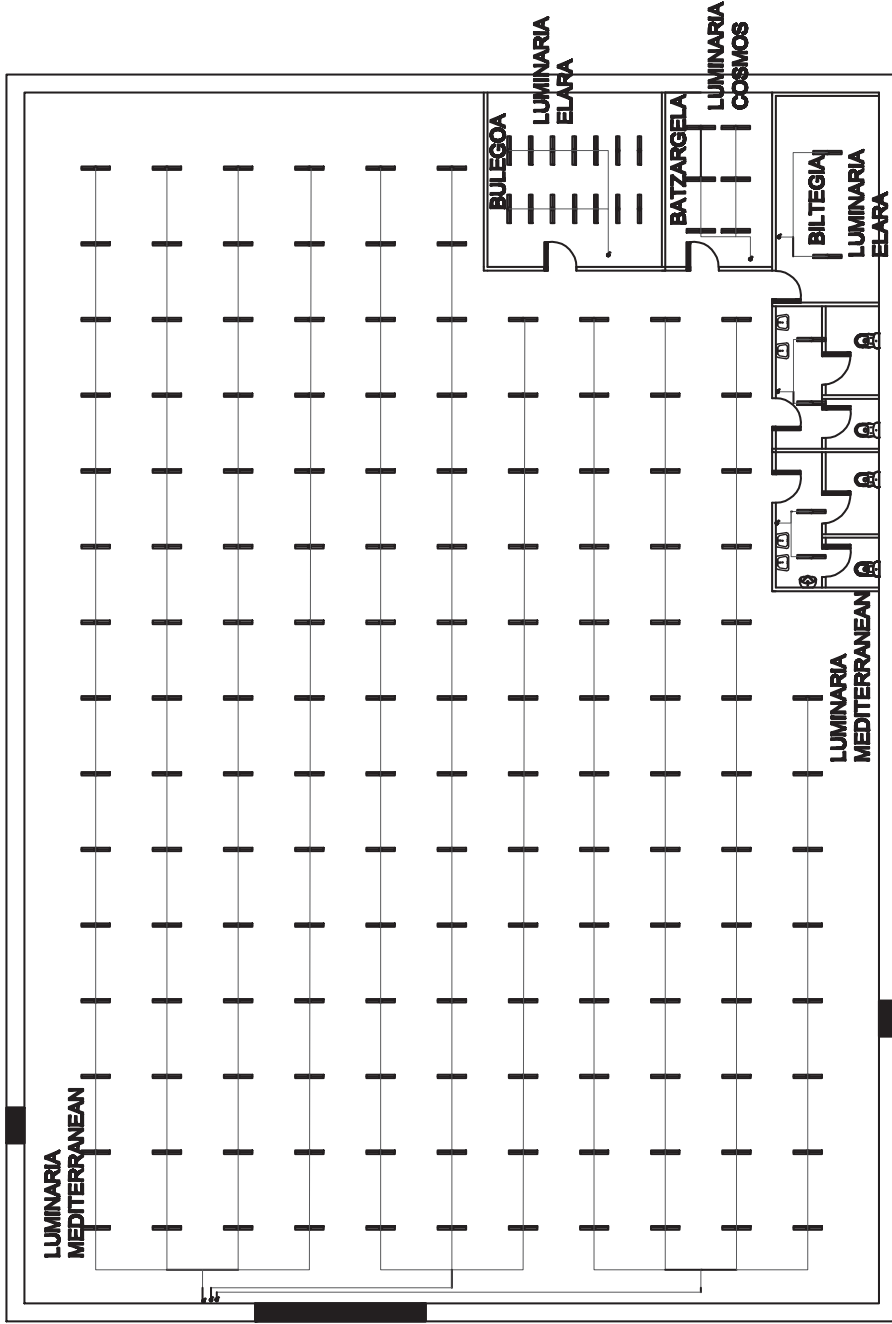

Marratztua:	2014-10-01	Izena	EUSKAL HERRIKO UNIBERTSITATEA	
	2015-01-30		BILBOKO INDUSTRI INGENIARITZA TEKNIKORAKO UNIBERTSITATE ESKOLA	
Gainbegiratua:	2015-01-30	Eskala	MANUETAKO DOMINIO BERZAL BODEGAREN ERIAKINA.	
Perdoi Orok.			SOLAIRUAREN BANAKETA	
			Plano Zkia.:	P20
			Plano Kop.:	20/23



E: 1/200

 EUSKAL HERRIKO UNIBERTSITATEA BILBOKO INDUSTRIA INGENIARITZA TEKNIKORAKO UNIBERTSITATE ESKOLA	 MANUETAKO DOMINIO BERZAL BODEGAREN ERIAKINA.	SOLAIRUAREN ARGIZTAPENA	
		Plano Zkia.: P21 Plano Kop.: 21/23	
Data 2014-10-01 2015-01-30	Izena CIBRAN DELGADO, LEIPE LARAUZOGOTIA ALZAGA, BERTEBAN		
Marraztua: Gainbegiratua:	Eskala 1/150		
	Perdoi Orak.		

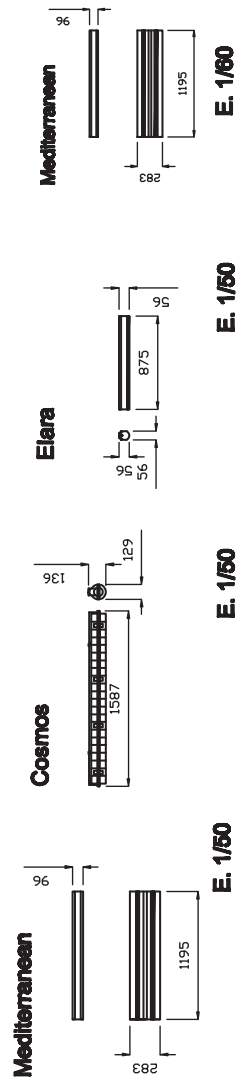

E: 1/60

E: 1/60

E: 1/60

E: 1/60

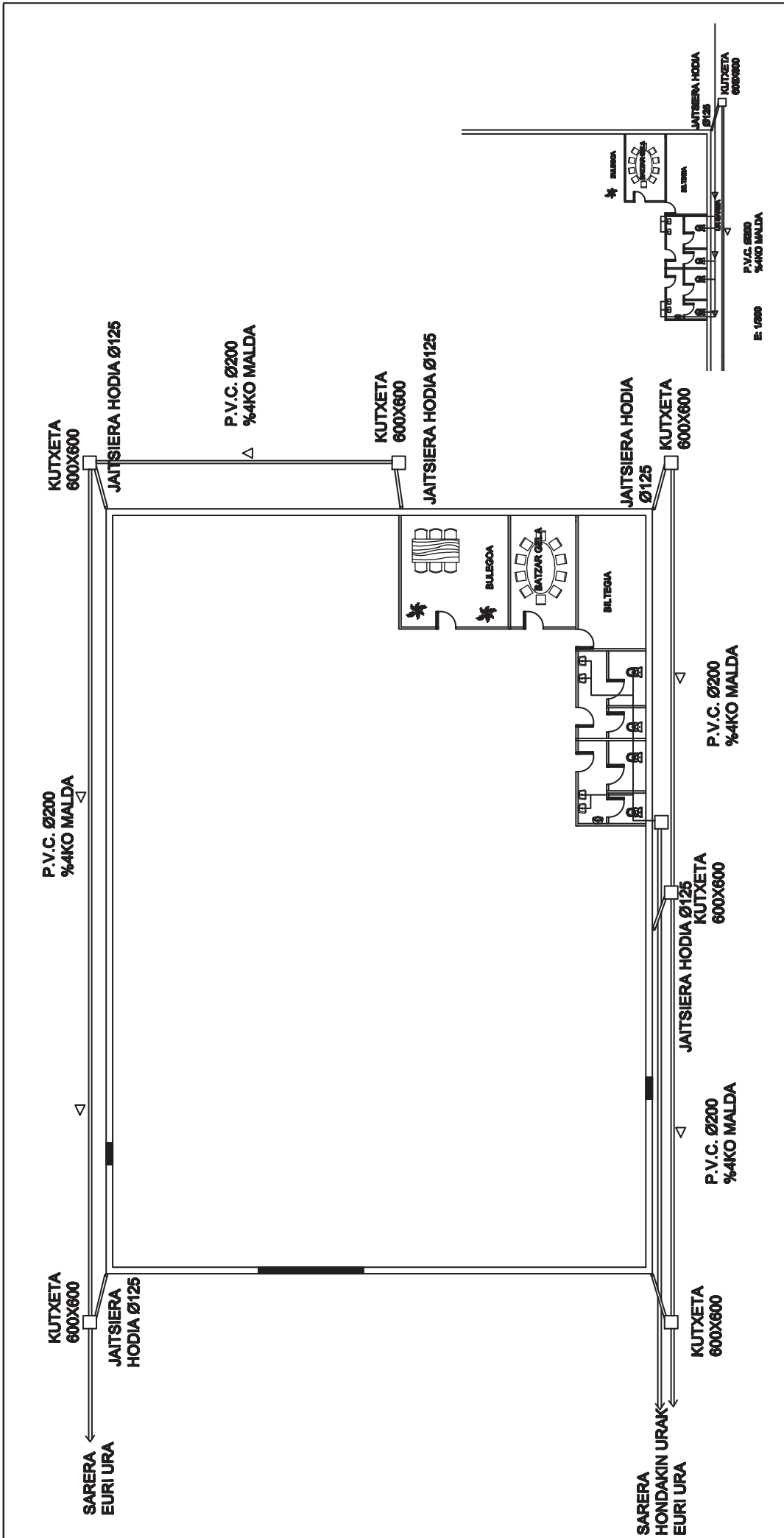

Marratzua:	Data		Izena
	2014-10-01	2014-10-01	
Gainbegiratua:	2015-01-30	LARRUGOITIA ALZAGA, ESTEBAN	
Perdoi Oroki.	Eskala		
	1/180		
LURPEKO SANEAMENDUA			
MANUETAKO DOMINIO BERZAL BODEGAREN ERIAKINA.			
Plano Zkia.:			P22
Plano Kop.:			22/23

KUTXEKA

E:1/40

EUSKAL HERRIKO UNIBERTSITATEA
BILBOKO INDUSTRIA INGENIARITZA
TEKNIKORAKO UNIBERTSITATE ESKOLA

EGITURAKO ATEAK

ATE NAGUSIA

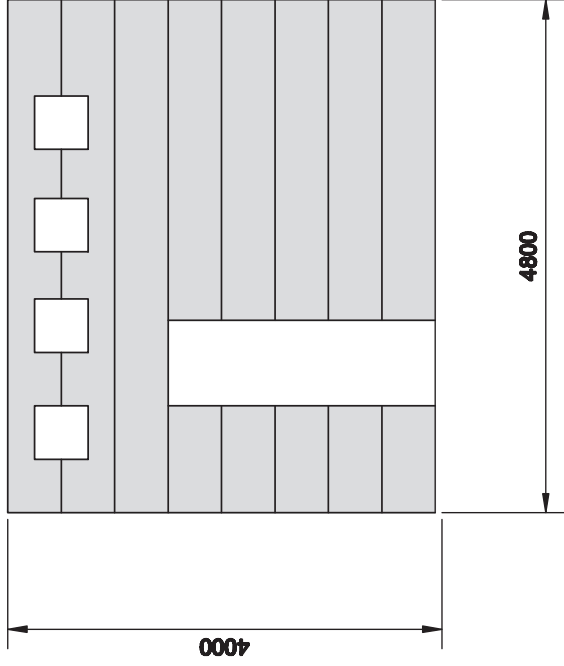

LARRIALDIKO IRTEERAK

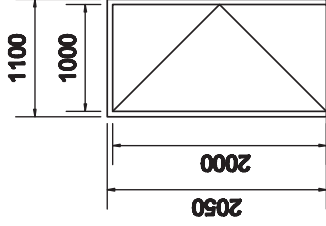

GELA EZBERDINEKO ATEAK

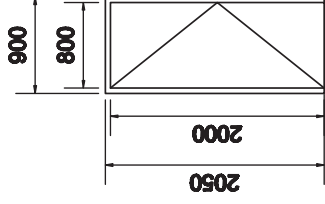

EGITURAKO LEHIOAK

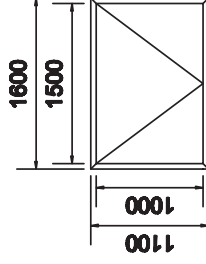

EUSKAL HERRIKO UNIBERTSITATEA BILKO INDUSTRIAL INGENIARITZA TEKNIKORAKO UNIBERTSITATE ESKOLA		EUSKAL HERRIKO UNIBERTSITATEA BILKO INDUSTRIAL INGENIARITZA TEKNIKORAKO UNIBERTSITATE ESKOLA	
Marratzua:		Izena	
2014-11-01		CIBRAN DELGADO, LEIRE	
Gainbegiratua:		2015-01-30	
LARRIALDIKO IRTEERAK		LARRIALDIKO IRTEERAK	
ALZAGA, ESTEBAN		ALZAGA, ESTEBAN	
Eskala		ZURGINTZA	
1/50		ZURGINTZA	
Perdoi Orok.		Plano Zkia.: P23	
Plano Kop.: 23/23		Plano Kop.: 23/23	