



BILBOKO
INGENIARITZA
ESKOLA
ESCUELA
DE INGENIERÍA
DE BILBAO

INGENIARITZA ZIBILA
GRADU AMAIERAKO LANA

***DRAINAKETA SISTEMA BERRIEN
DISEINU TEKNIKO ETA HIDRAULIKOA
BILBOKO EUROPA PARKEAN.***

2.DOKUMENTUA: PLANOAK.

Ikaslea: San Pedro Villalba, Josu

Zuzendaria: Madrazo Uribeetxebarria, Eneko

Ikasturtea: 2019-2020

Data: Bilbon, 2020-ko ekainaren 2-an

PLANOEN AURKIBIDEA

ARAZODUN GUNEEN KOKAPENA.....	1
1.GUNEA.....	2
2.GUNEA.....	3
3.GUNEA.....	4
4.GUNEA.....	5
5.GUNEA A.....	6
5.GUNEA B.....	7
5.GUNEA C.....	8
5.GUNEA D.....	9
5.GUNEA E.....	10
5.GUNEA F.....	11
5.GUNEA G.....	12
5.GUNEA F.....	13
6.GUNEA.....	14

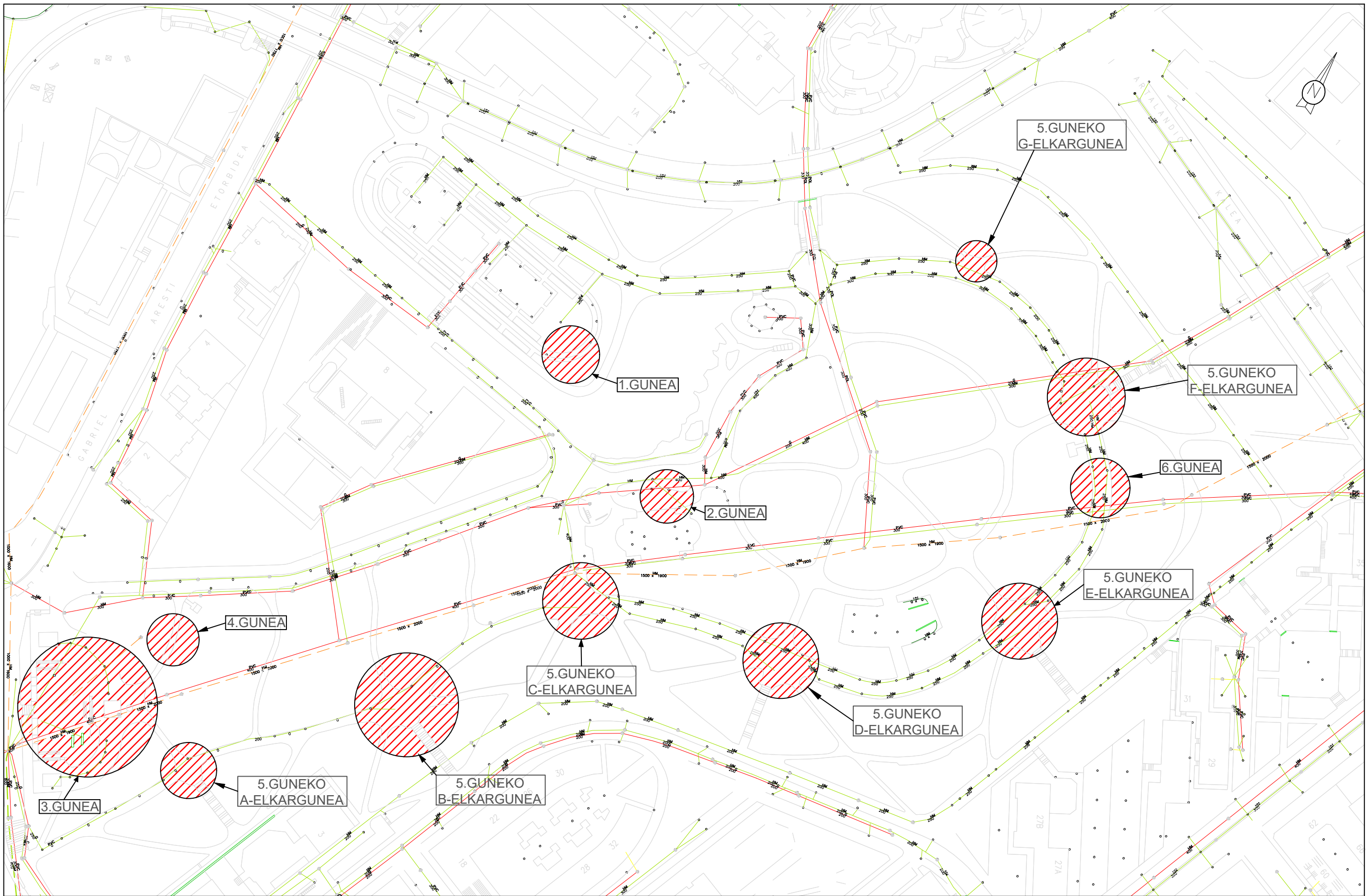

LEGENDA

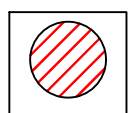

DRAINAKETA ARAZOA DUEN AZALERA

ESKALA:
ESCALA: **DIN A3 1:1500**

EGILEA:
AUTOR: **JOSU SAN PEDRO VILLALBA**

PLANOA:
PLANO: **ARAZODUN GUNEEN KOKAPENA
UBICACIÓN DE LAS ZONAS PROBLEMÁTICAS**

ERAKUNDEA:
INSTITUCIÓN: **EHU/UPV**

KOKAPENA:
UBICACIÓN: **EUROPA PARKEA (BILBO)**

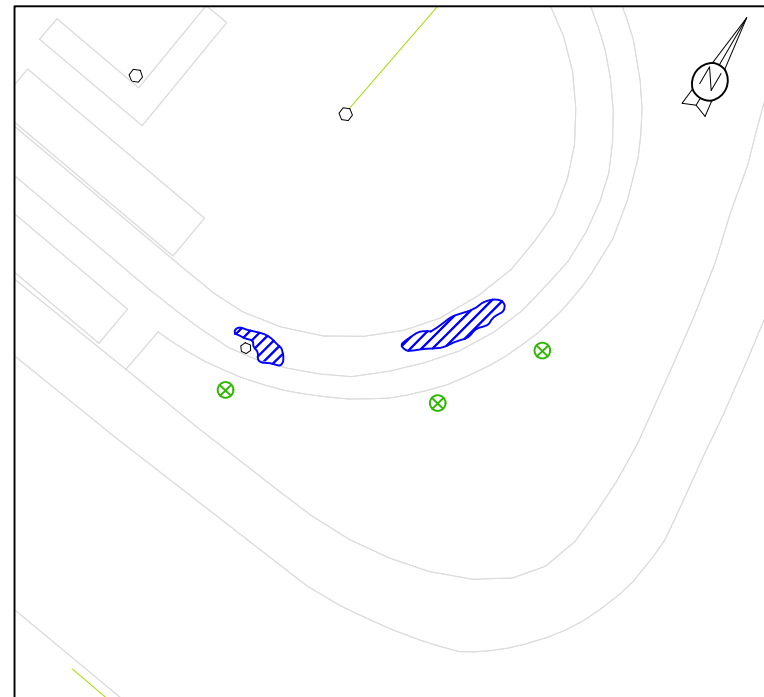

GAUR EGUNGO EGOERA
Oinplanta
E: 1:500

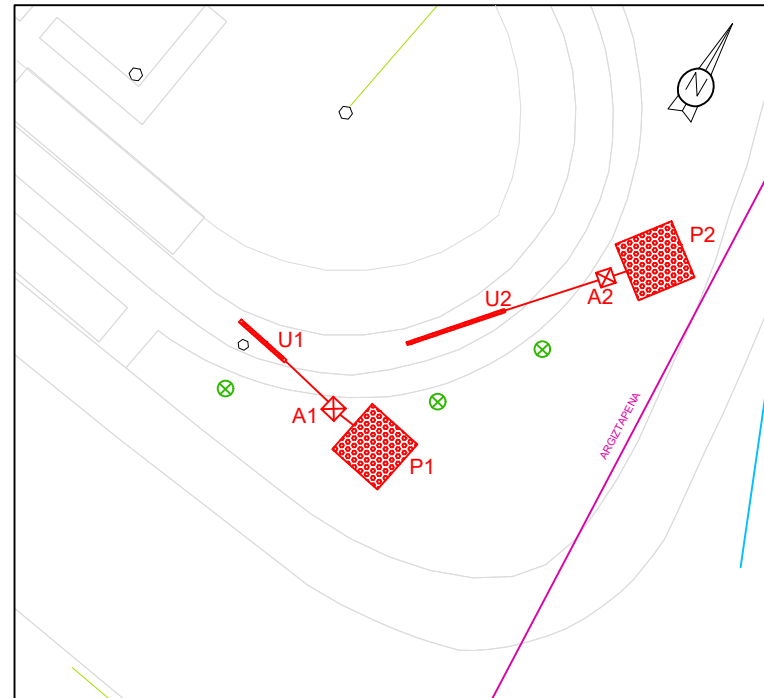

PROPOSATURIKO SOLUZIOA
Oinplanta
E: 1:500

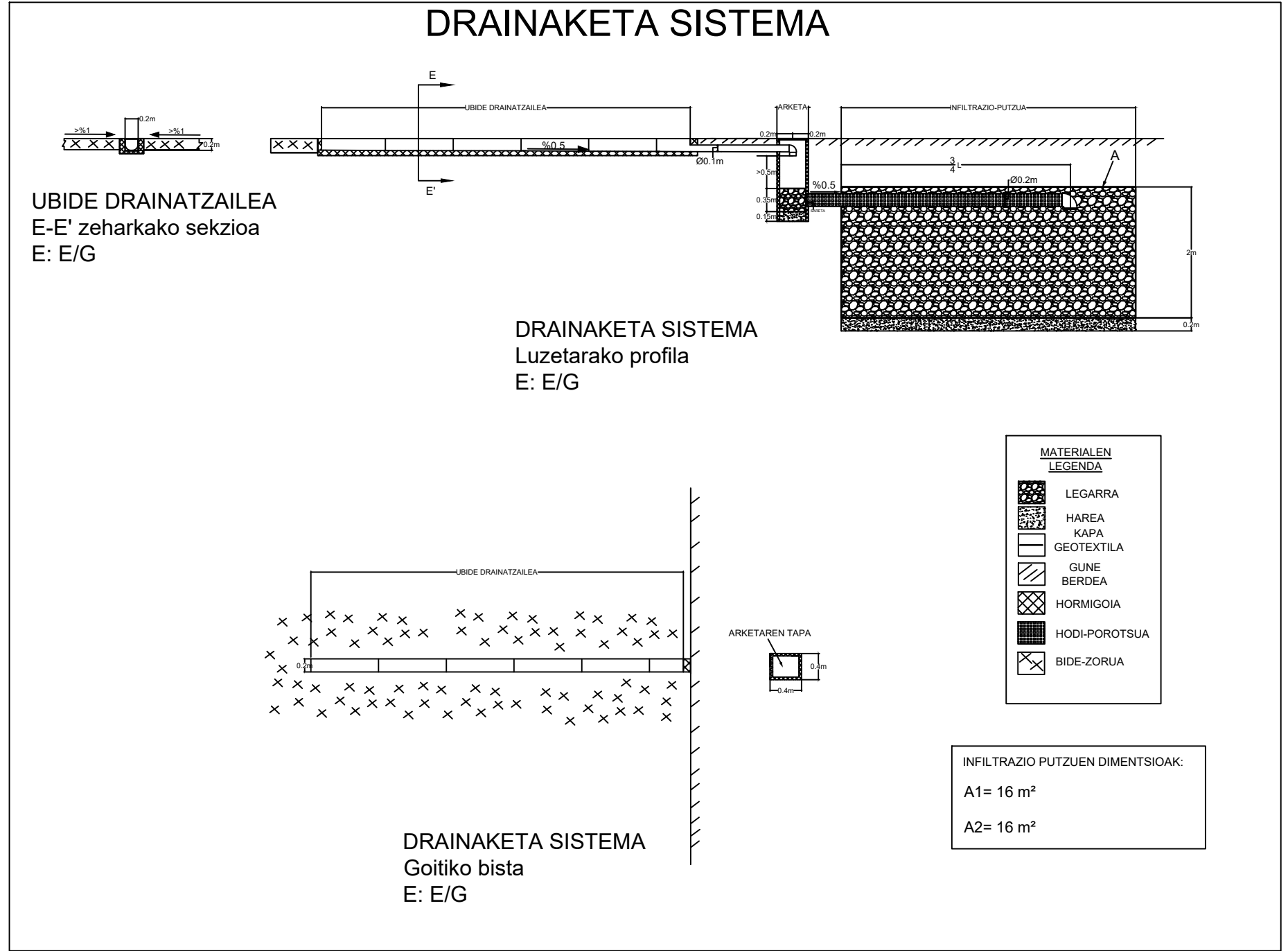

<p>LEGENDA</p> <table style="width: 100%;"> <tr> <td> UR EDO/ETA SEDIMENTU METAKETA</td> <td> KALE-ARGIA</td> <td> UR ISURKETA</td> </tr> <tr> <td> BANKUA</td> <td> ESTOLDA-PUTZUA</td> <td> SANEAMENDU SAREA</td> </tr> <tr> <td> ZUHAITZA</td> <td> ITURRIA</td> <td> DRAINAKETA UBIDEA (U)</td> </tr> <tr> <td> HODITERIA BERRIA</td> <td> ZAKARRONTZIA</td> <td> ARKETA (A)</td> </tr> <tr> <td> INFILTRAZIO-PUTZUA (P)</td> <td> FEKAL SAREA</td> <td> INFILTRAZIO ZANGA</td> </tr> </table>			UR EDO/ETA SEDIMENTU METAKETA	KALE-ARGIA	UR ISURKETA	BANKUA	ESTOLDA-PUTZUA	SANEAMENDU SAREA	ZUHAITZA	ITURRIA	DRAINAKETA UBIDEA (U)	HODITERIA BERRIA	ZAKARRONTZIA	ARKETA (A)	INFILTRAZIO-PUTZUA (P)	FEKAL SAREA	INFILTRAZIO ZANGA	<p>EGILEA: AUTOR:</p> <p style="text-align: center;">JOSU SAN PEDRO VILLALBA</p>	<p>PLANOA: PLANO:</p> <p style="text-align: center;">1.GUNEA</p>
UR EDO/ETA SEDIMENTU METAKETA	KALE-ARGIA	UR ISURKETA																	
BANKUA	ESTOLDA-PUTZUA	SANEAMENDU SAREA																	
ZUHAITZA	ITURRIA	DRAINAKETA UBIDEA (U)																	
HODITERIA BERRIA	ZAKARRONTZIA	ARKETA (A)																	
INFILTRAZIO-PUTZUA (P)	FEKAL SAREA	INFILTRAZIO ZANGA																	
<p>ERAKUNDEA: INSTITUCIÓN:</p> <p style="text-align: center;">EHU/UPV</p>		<p>KOKAPENA: UBICACIÓN:</p> <p style="text-align: center;">EUROPA PARKEA (BILBO)</p>																	

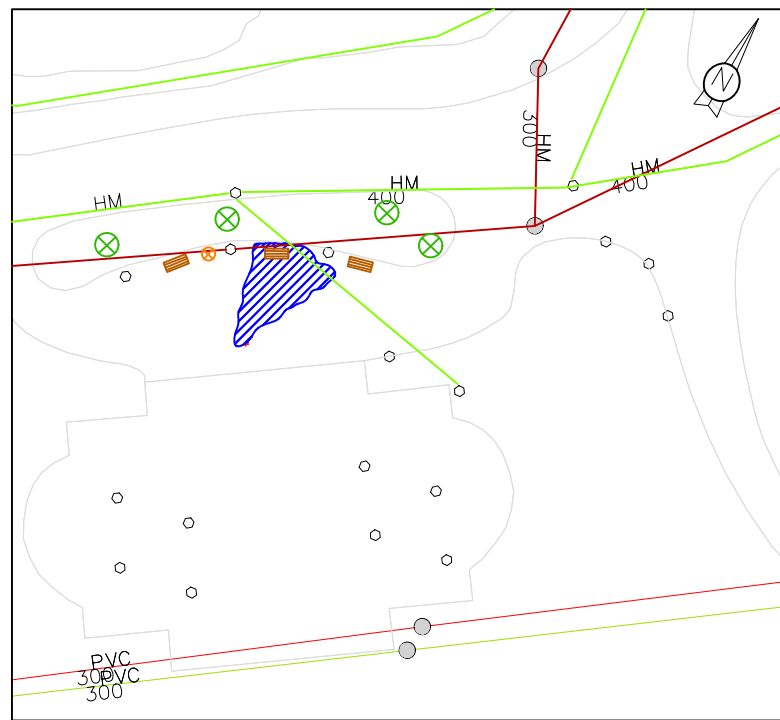

GAUR EGUNGO EGOERA
Oinplanta
E: 1:500

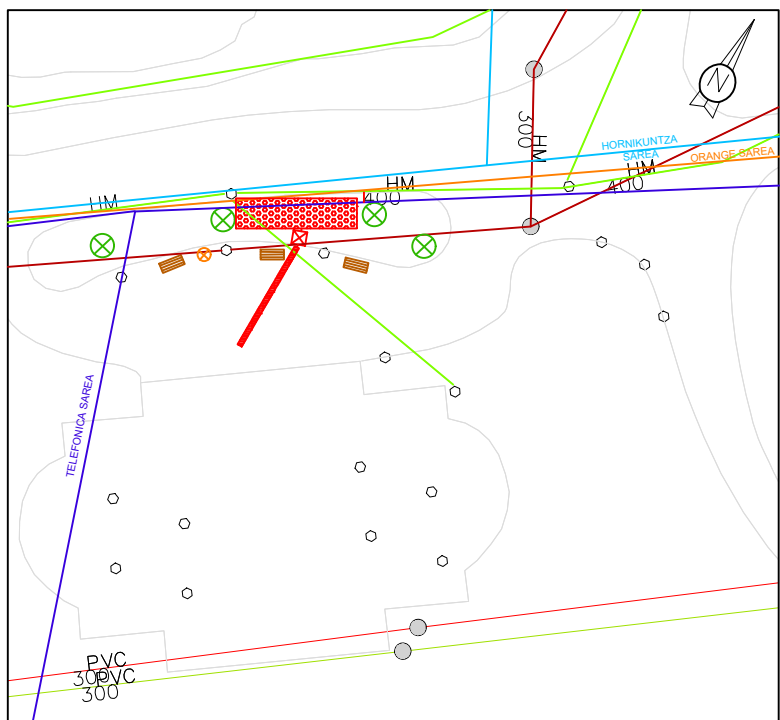

PROPOSATURIKO SOLUZIOA
Oinplanta
E: 1:500

LEGENDA

- | | | |
|-------------------------------|----------------|-------------------|
| UR EDO/ETA SEDIMENTU METAKETA | KALE-ARGIA | UR ISURKETA |
| BANKUA | ESTOLDA-PUTZUA | SANEAMENDU SAREA |
| ZUHAITZA | ITURRIA | DRAINAKETA UBIDEA |
| HODITERIA BERRIA | ZAKARRONTZIA | ARKETA |
| INFILTRAZIO-PUTZUA (P) | FEKAL SAREA | INFILTRAZIO ZANGA |

DRAINAKETA SISTEMA

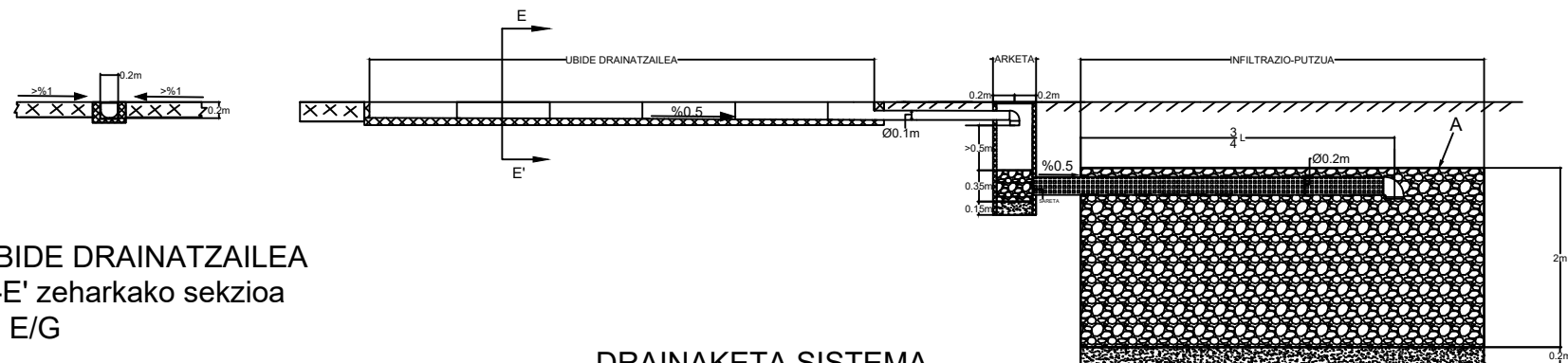

UBIDE DRAINATZAILEA
E-E' zeharkako sekzioa
E: E/G

DRAINAKETA SISTEMA
Luzetarako profila
E: E/G

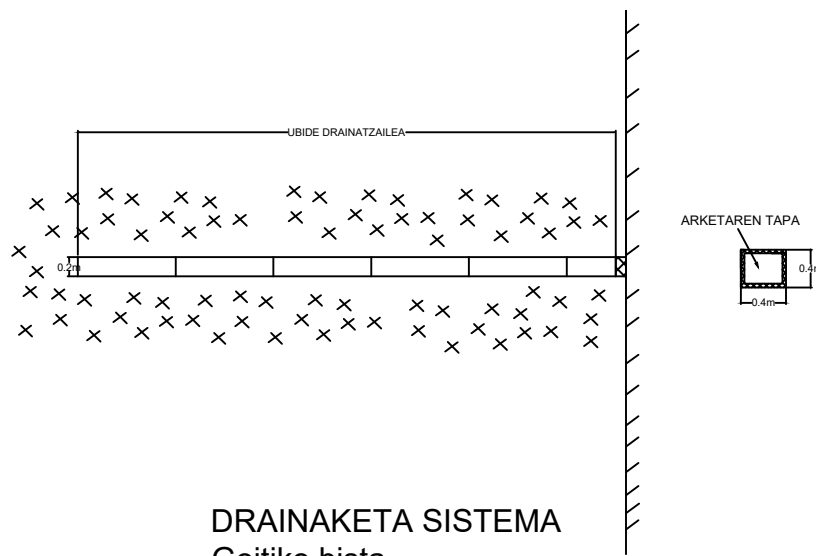

DRAINAKETA SISTEMA
Goitiko bista
E: E/G

- MATERIALEN LEGENDA**
- LEGARRA
 - HAREA
 - KAPA
 - GEOTEXTILA
 - GUNE BERDEA
 - HORMIGOIA
 - HODI-POROTSUA
 - BIDE-ZORUA

INFILTRAZIO PUTZUAREN DIMENTSIOA:
A= 16 m²

EGILEA:
AUTOR: **JOSU SAN PEDRO VILLALBA**

PLANOA:
PLANO: **2.GUNEA**

ERAKUNDEA:
INSTITUCIÓN: **EHU/UPV**

KOKAPENA:
UBICACIÓN: **EUROPA PARKEA (BILBO)**

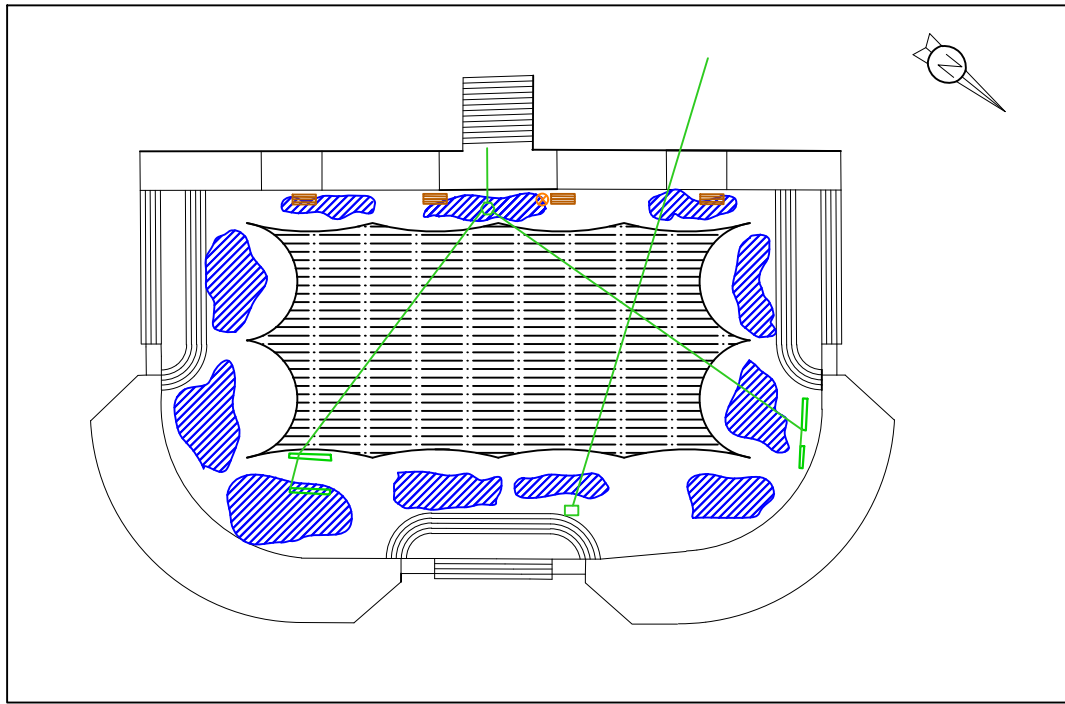

GAUR EGUNGO EGOERA
Oinplanta
E= 1:500

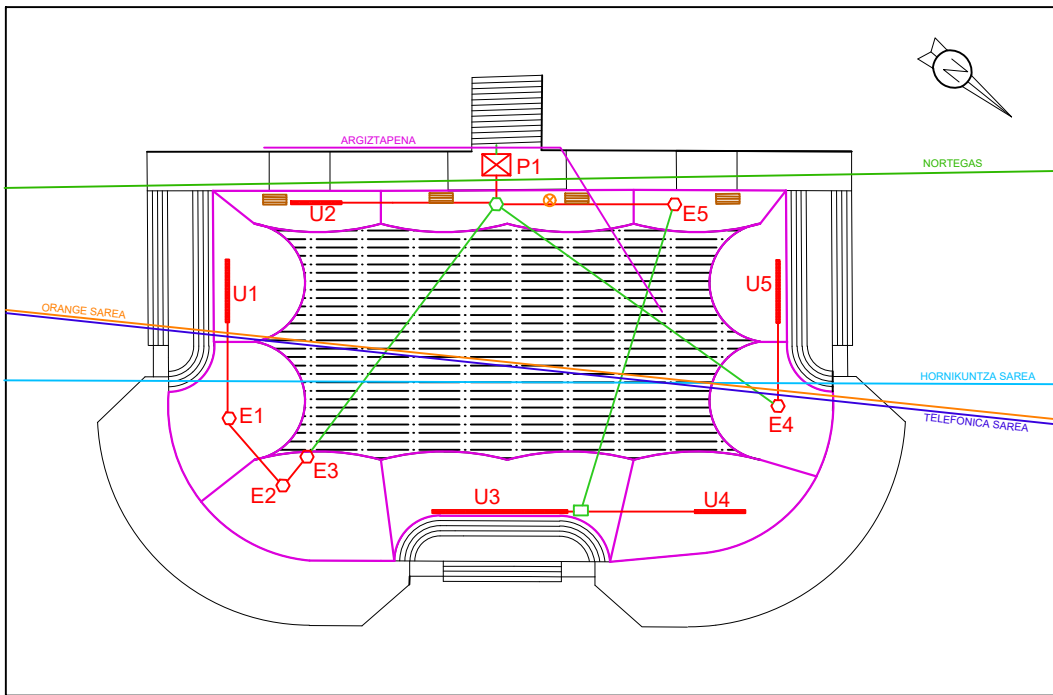

PROPOSATURIKO SOLUZIOA
Oinplanta
E= 1:500

- MATERIALEN LEGENDA**
- LEGARRA
 - HAREA
 - KAPA GEOTEXTILA
 - ZORUA NIBELATZEKO MORTEROA
 - SISTEMA DRAINATZAILEA INSTALATZEKO MORTEROA
 - PUTZUAREN INGURUKO HORMIGOIA
 - EPOXI KAPA

DRAINAKETA SISTEMA

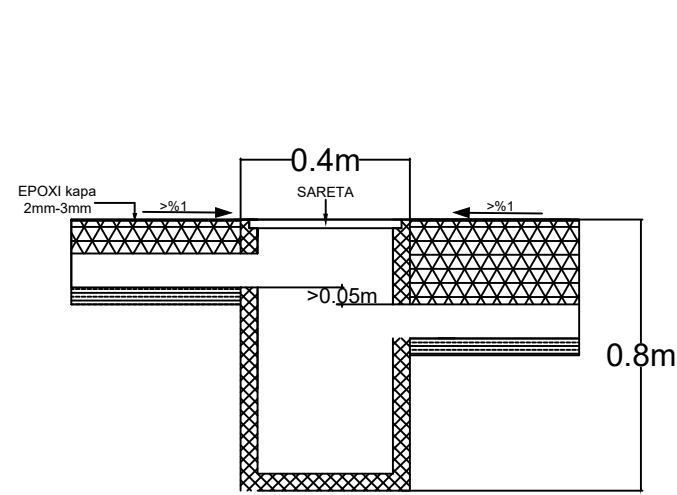

ESTOLDA-ZULOA
Luzetarako profil orokorra
E= E/G

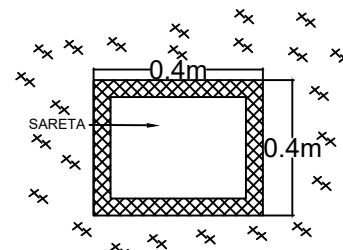

ESTOLDA-ZULOA
Goitiko bista orokorra
E= E/G

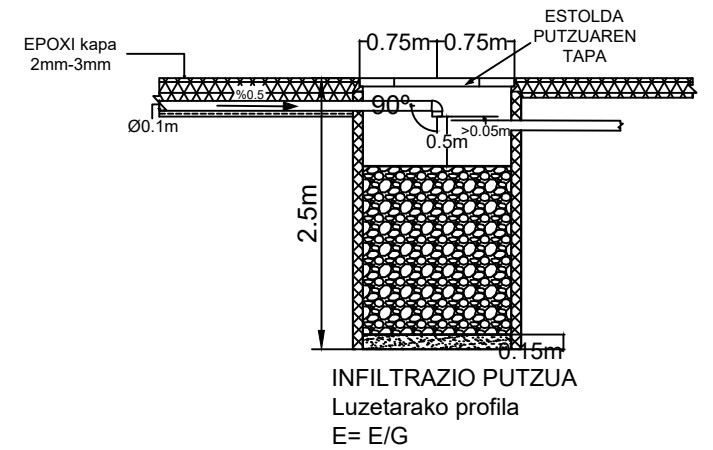

INFILTRAZIO PUTZUA
Luzetarako profila
E= E/G

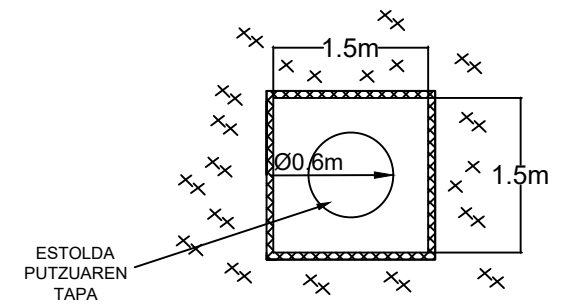

INFILTRAZIO PUTZUA
Goitiko bista
E= E/G

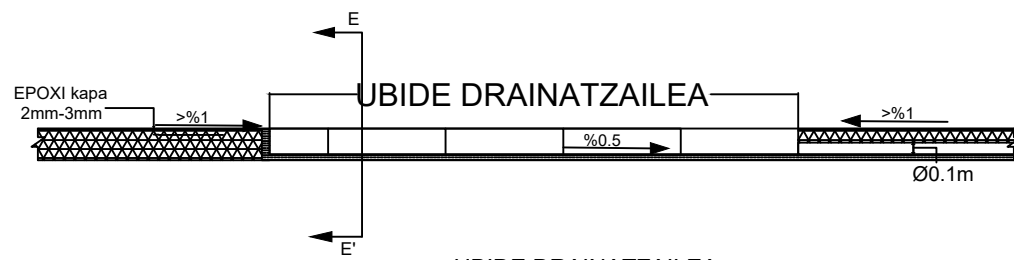

UBIDE DRAINATZAILEA
Luzetarako profila
E= E/G

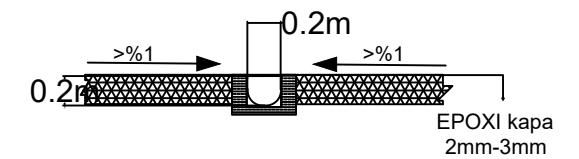

UBIDE DRAINATZAILEA
E-E' Zeharkako sekzioa
E= E/G

LEGENDA

- UR EDO/ETA SEDIMENTSU METAKETA
- GAUR EGUNGO ESTOLDA-ZULOA
- GAUR EGUNGO HODIA
- GAUR EGUNGO ARKETA
- GAUR EGUNGO UBIDE DRAINATZAILEA
- UBIDE DRAINATZAILE BERRIA (U)
- INFILTRAZIO PUTZUA (P)
- ESTOLDA-ZULO BERRIA (E)
- HODI BERRIA
- ZAKARRONTZIA
- BANKUA
- ARROAREN MUGAK
- ATERPEA

EGILEA:
AUTOR: **JOSU SAN PEDRO VILLALBA**

PLANOA:
PLANO: **3.GUNEAREN JOLASTOKIA**

ERAKUNDEA:
INSTITUCIÓN: **EHU/UPV**

KOKAPENA:
UBICACIÓN: **EUROPA PARKEA**

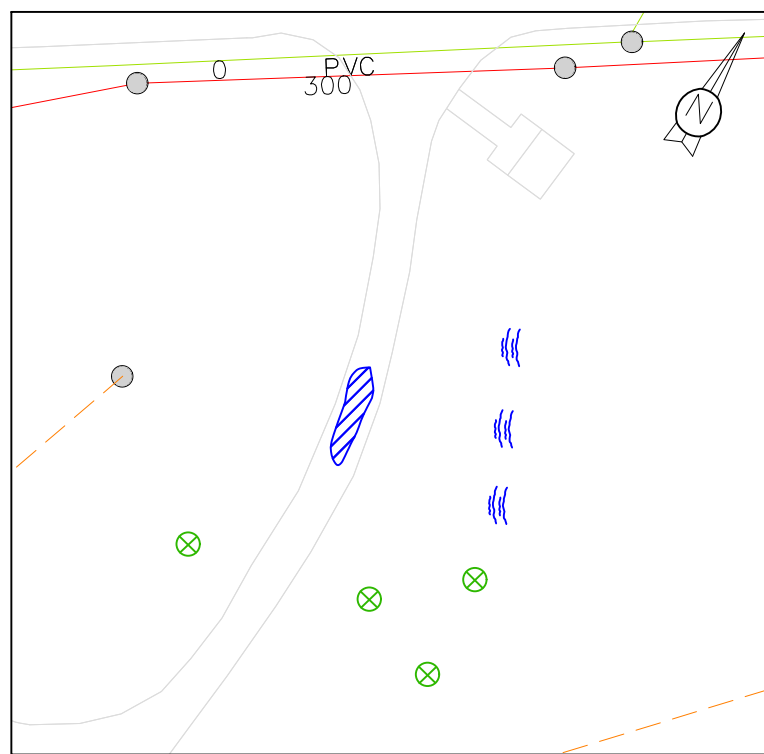

GAUR EGUNGO EGOERA
Oinplanta
E: 1:500

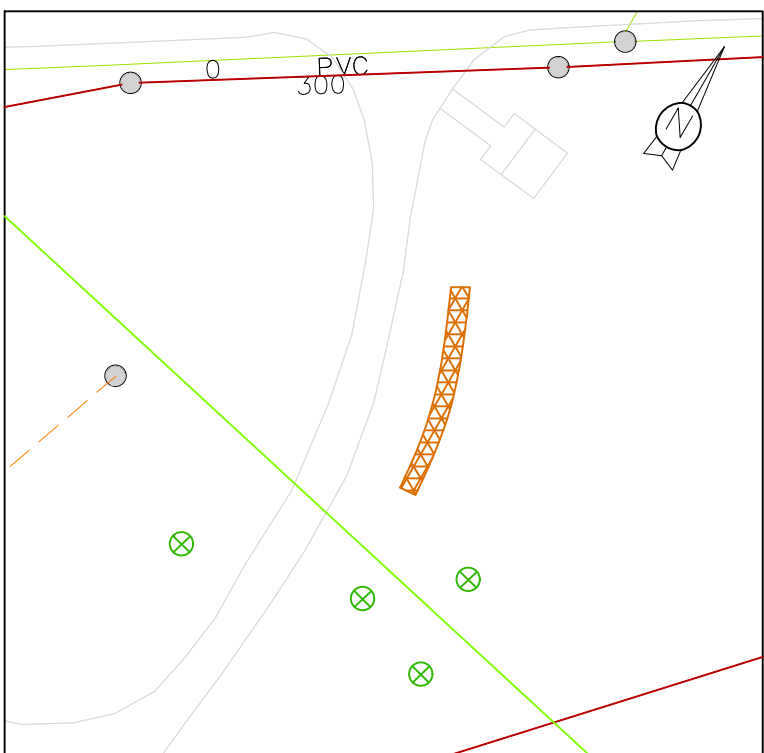

PROPOSATURIKO SOLUZIOA
Oinplanta
E: 1:500

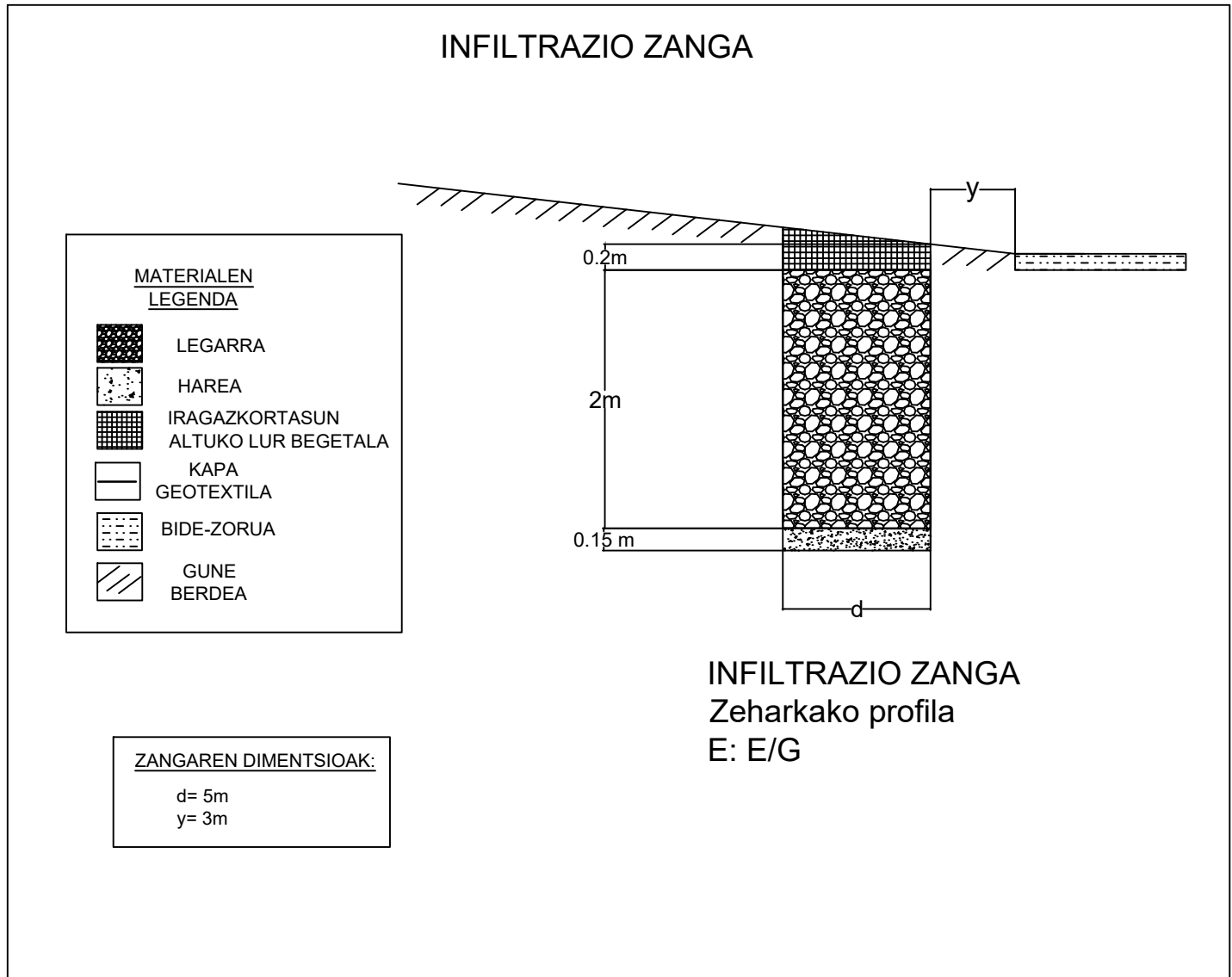

INFILTRAZIO ZANGA
Zeharkako profila
E: E/G

LEGENDA		

EGILEA: AUTOR:	JOSU SAN PEDRO VILLALBA
ERAKUNDEA: INSTITUCIÓN:	EHU/UPV

PLANOA: PLANO:	4.GUNEA
KOKAPENA: UBICACIÓN:	EUROPA PARKEA (BILBO)

CREADO CON UNA VERSION PARA ESTUDIANTES DE AUTODESK

CREADO CON UNA VERSION PARA ESTUDIANTES DE AUTODESK

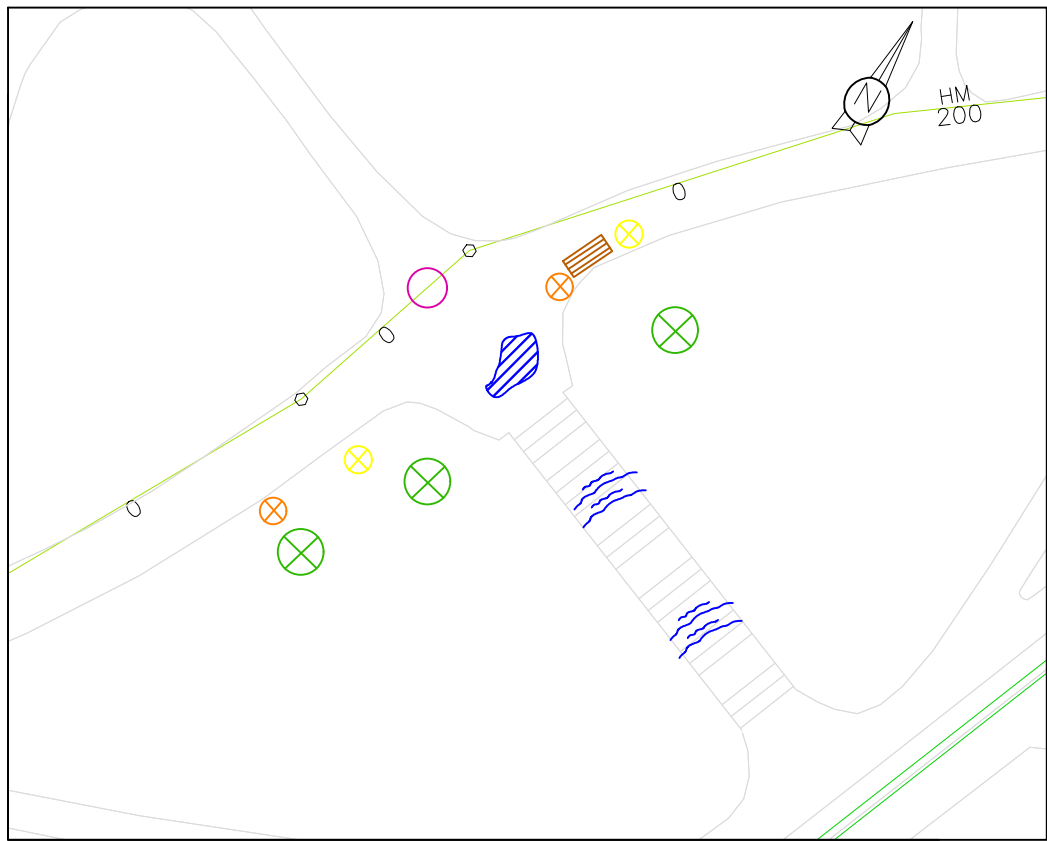

GAUR EGUNGO EGOERA
Oinplanta
E: 1:500

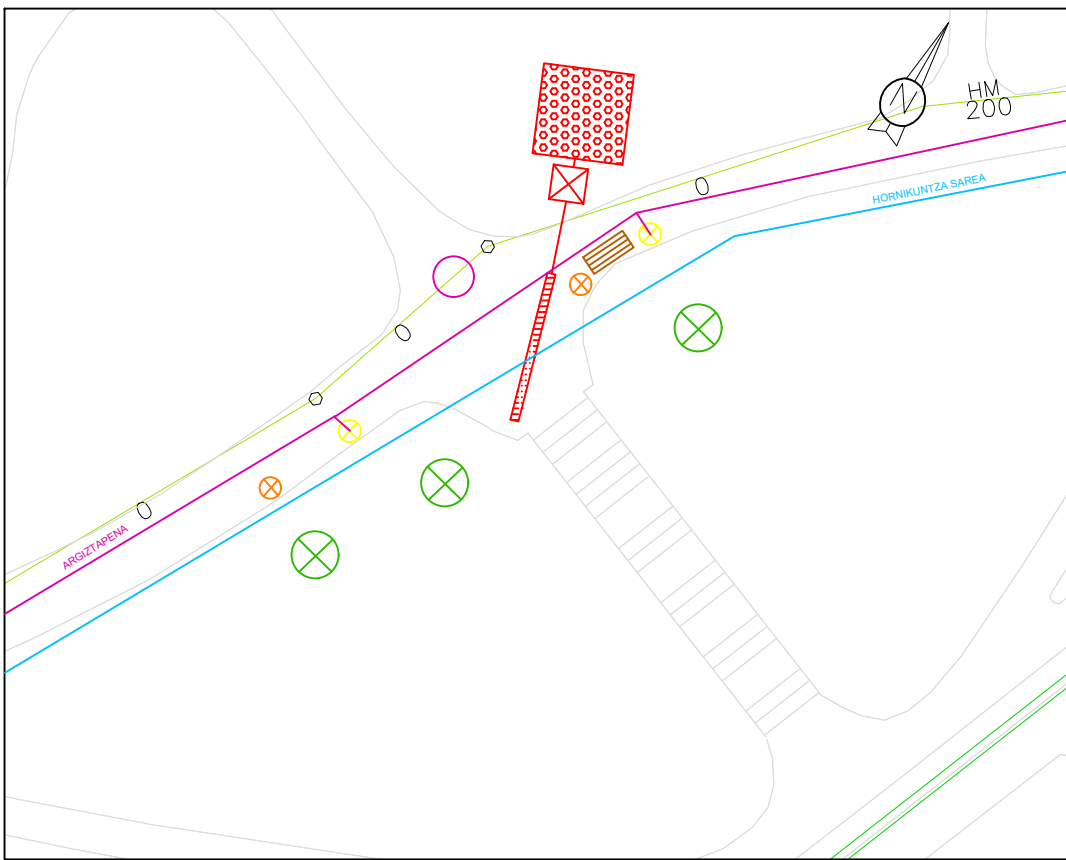

PROPOSATURIKO SOLUZIOA
Oinplanta
E: 1:500

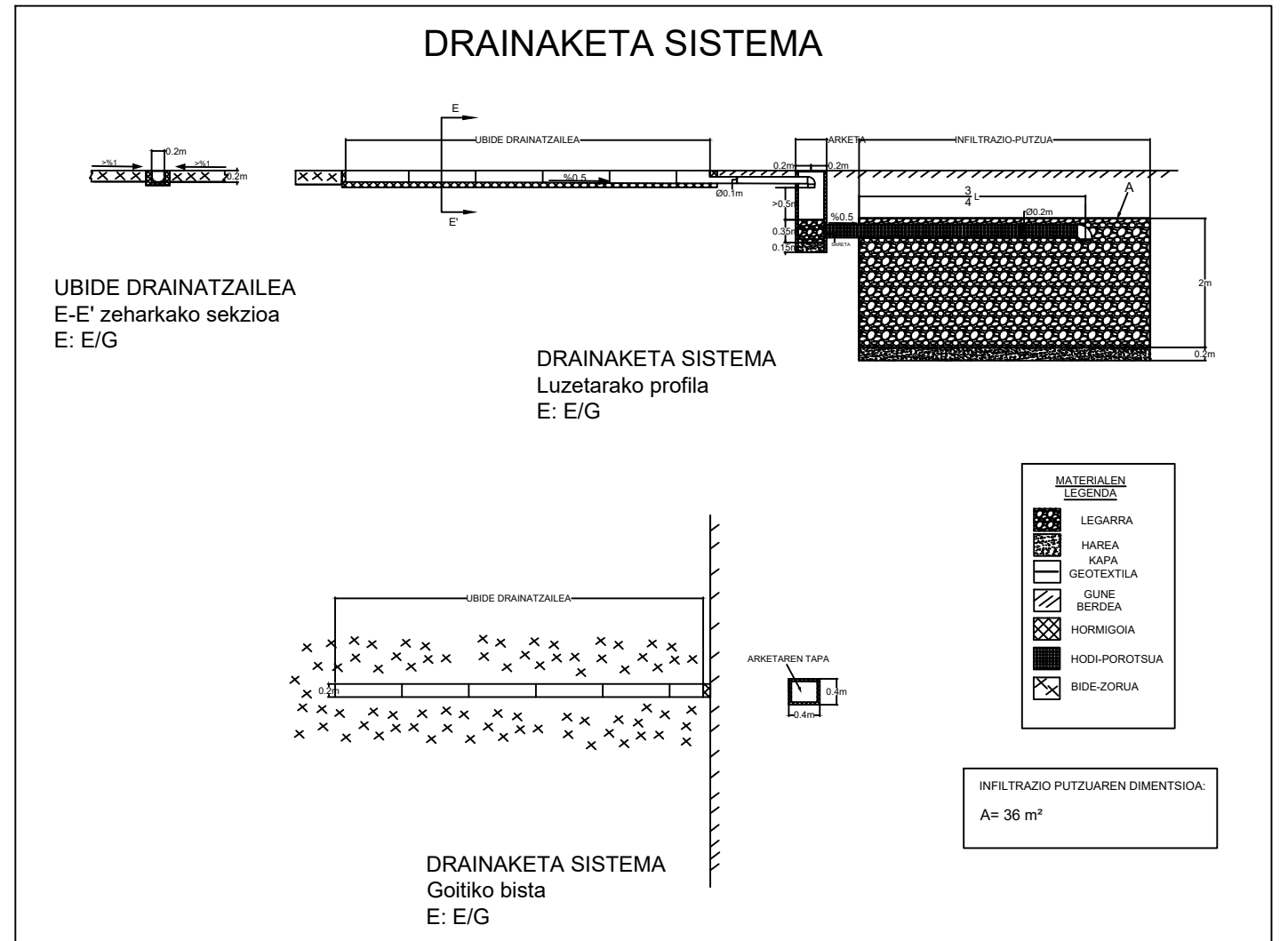

LEGENDA

- | | | |
|-------------------------------|----------------|-------------------|
| UR EDO/ETA SEDIMENTU METAKETA | KALE-ARGIA | UR ISURKETA |
| BANKUA | ESTOLDA-PUTZUA | SANEAMENDU SAREA |
| ZUHAITZA | ITURRIA | DRAINAKETA UBIDEA |
| HODITERIA BERRIA | ZAKARRONTZIA | ARKETA |
| INFILTRAZIO-PUTZUA | FEKAL SAREA | INFILTRAZIO ZANGA |

EGILEA:
AUTOR: JOSU SAN PEDRO VILLALBA

PLANOA:
PLANO: 5.GUNeko A ELKARGUNEA

ERAKUNDEA:
INSTITUCIÓN: EHU/UPV

KOKAPENA:
UBICACIÓN: EUROPA PARKEA (BILBO)

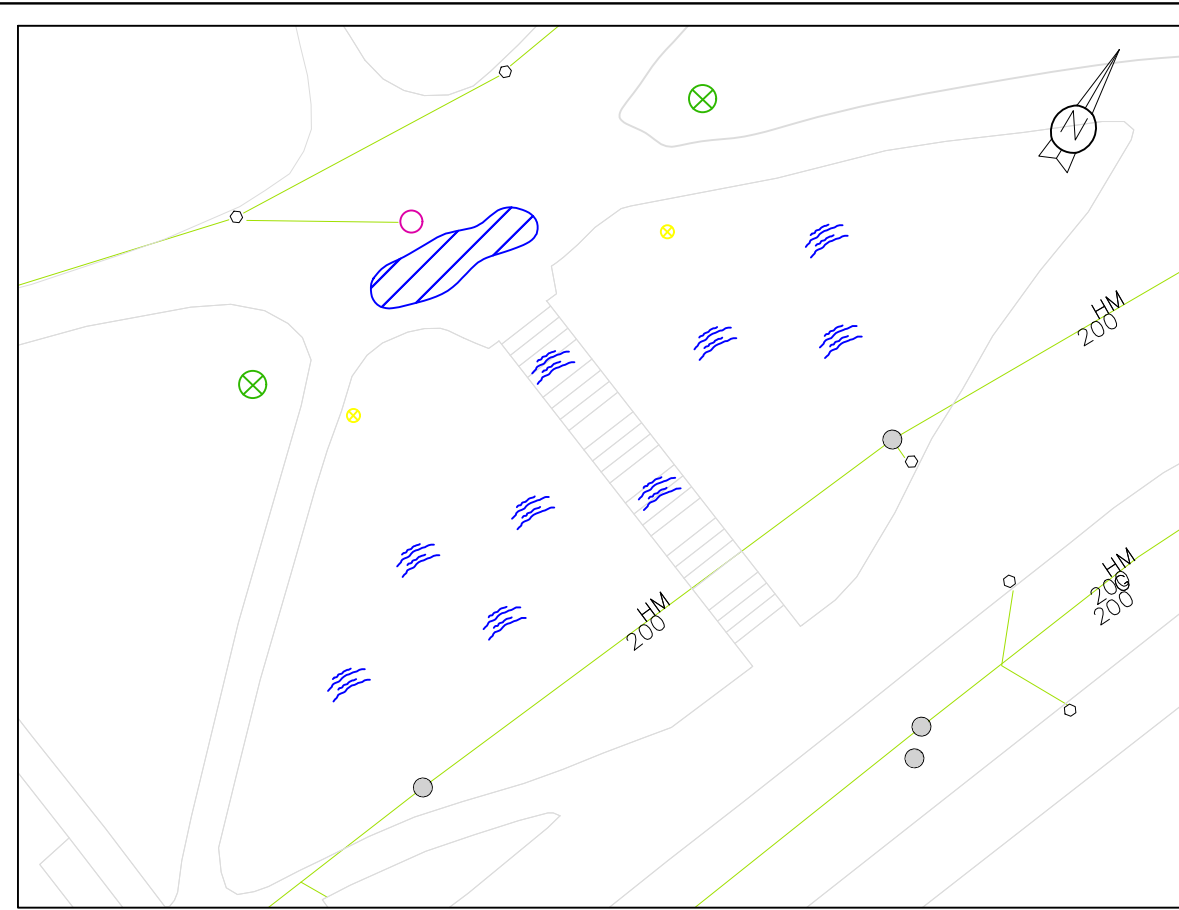

GAUR EGUNGO EGOERA
Oinplanta
E: 1:500

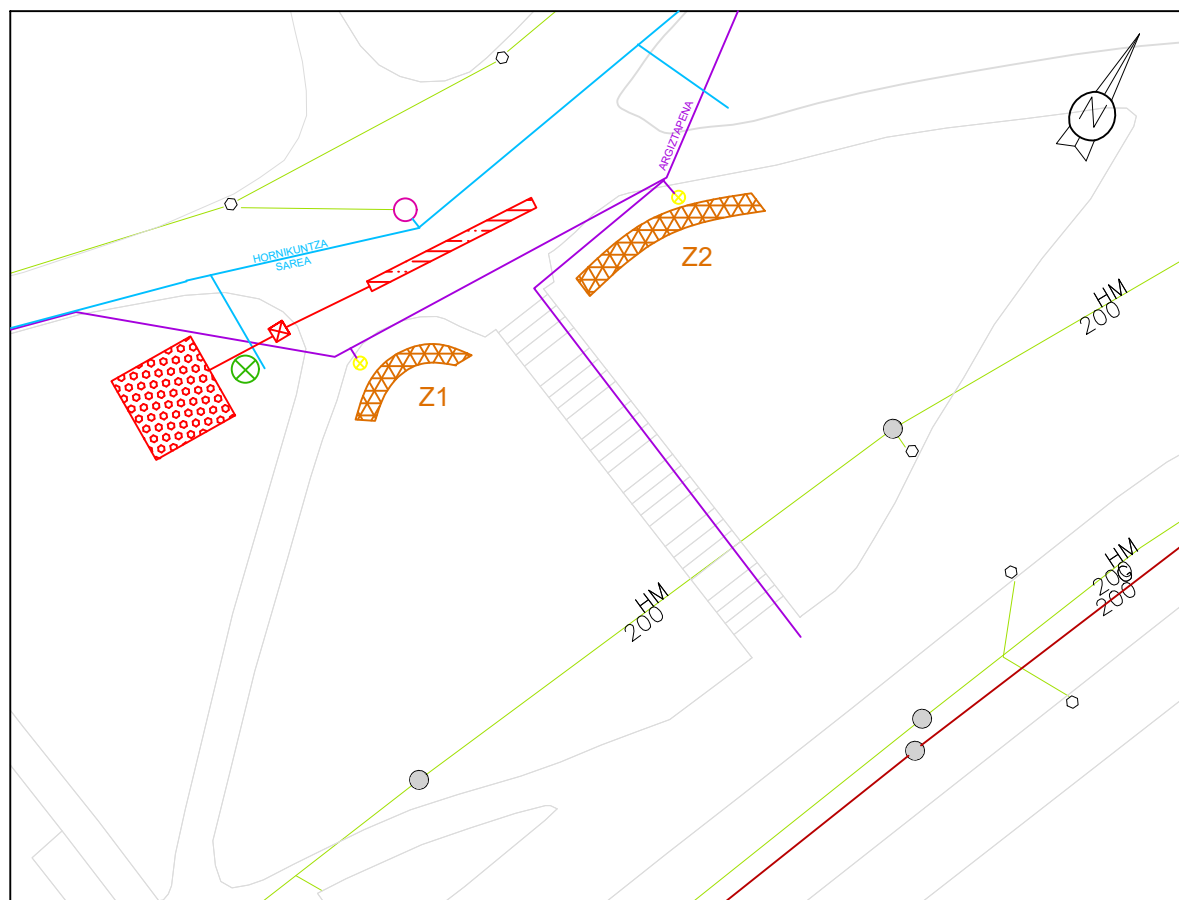

PROPOSATURIKO SOLUZIOA
Oinplanta
E: 1:500

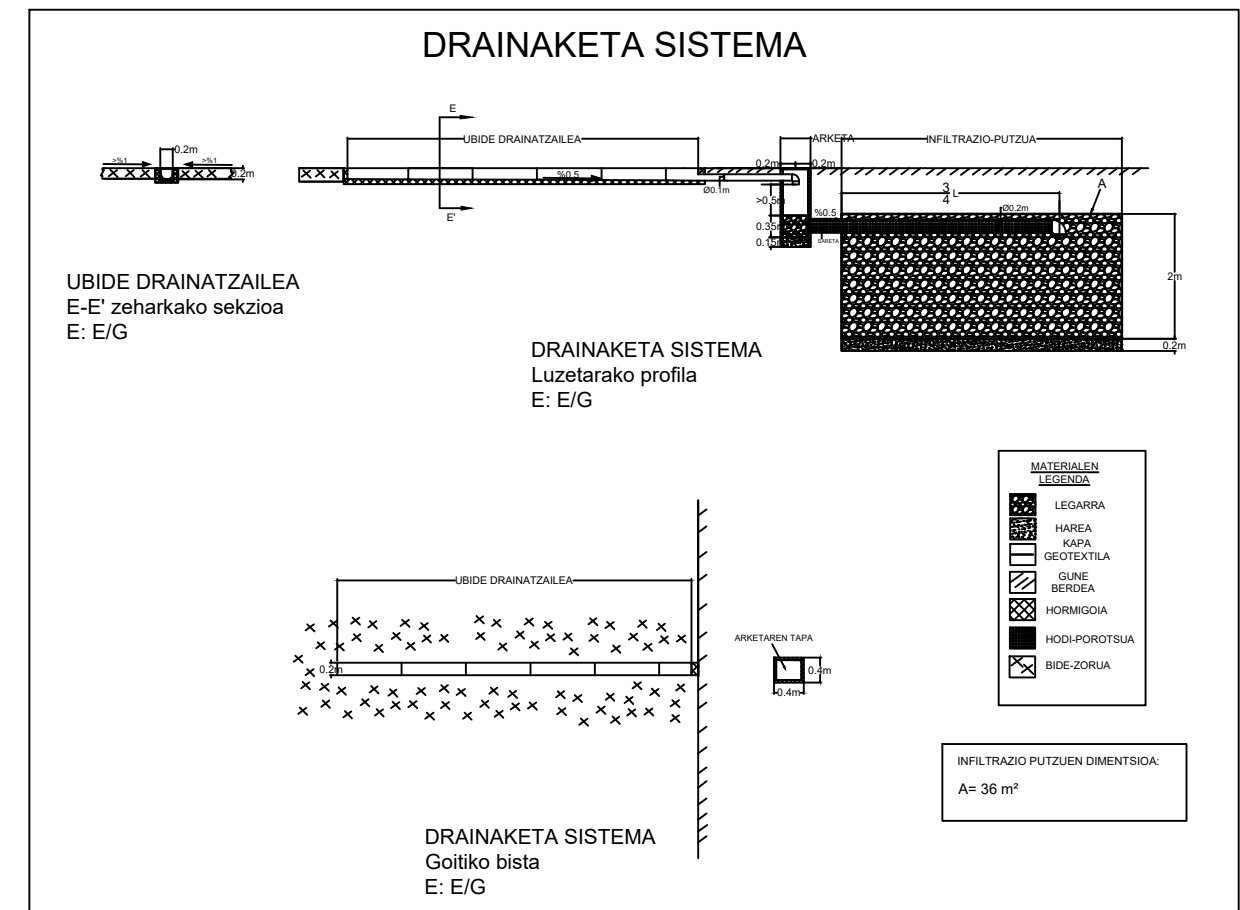
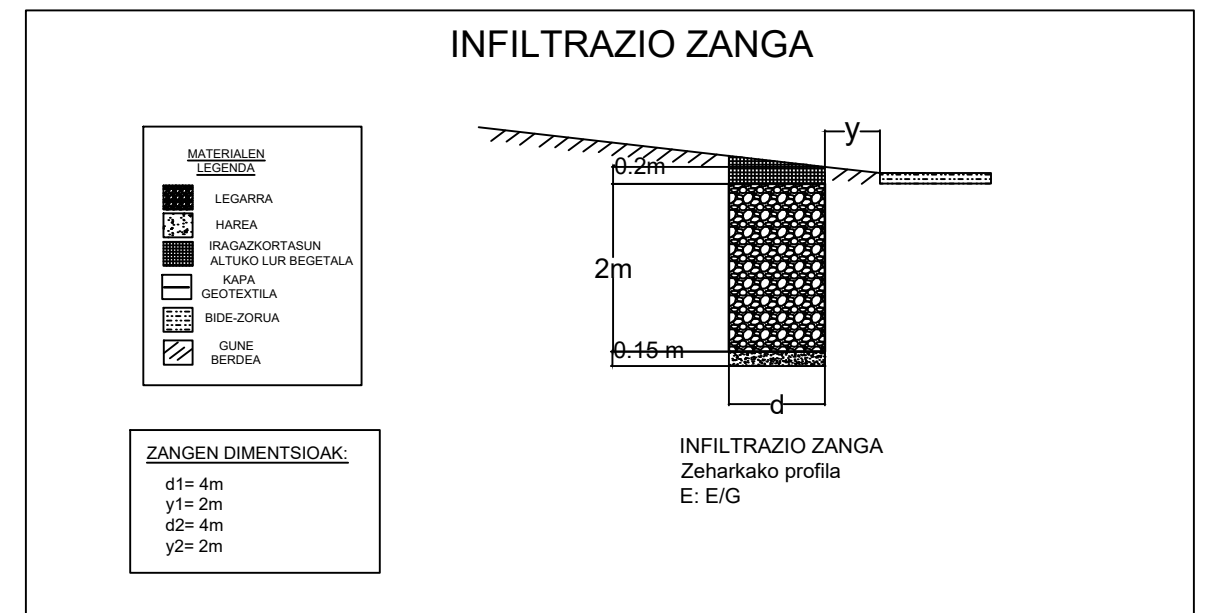

LEGENDA

- | | | |
|-------------------------------|----------------|-----------------------|
| UR EDO/ETA SEDIMENTU METAKETA | KALE-ARGIA | UR ISURKETA |
| BANKUA | ESTOLDA-PUTZUA | SANEAMENDU SAREA |
| ZUHAITZA | ITURRIA | DRAINAKETA UBIDEA |
| HODITERIA BERRIA | ZAKARRONTZIA | ARKETA |
| INFILTRAZIO-PUTZUA | FEKAL SAREA | INFILTRAZIO ZANGA (Z) |

EGILEA:
AUTOR: JOSU SAN PEDRO VILLALBA

PLANOA:
PLANO: 5.GUNeko B ELKARGUNEA

ERAKUNDEA:
INSTITUCIÓN: EHU/UPV

KOKAPENA:
UBICACIÓN: EUROPA PARKEA (BILBO)

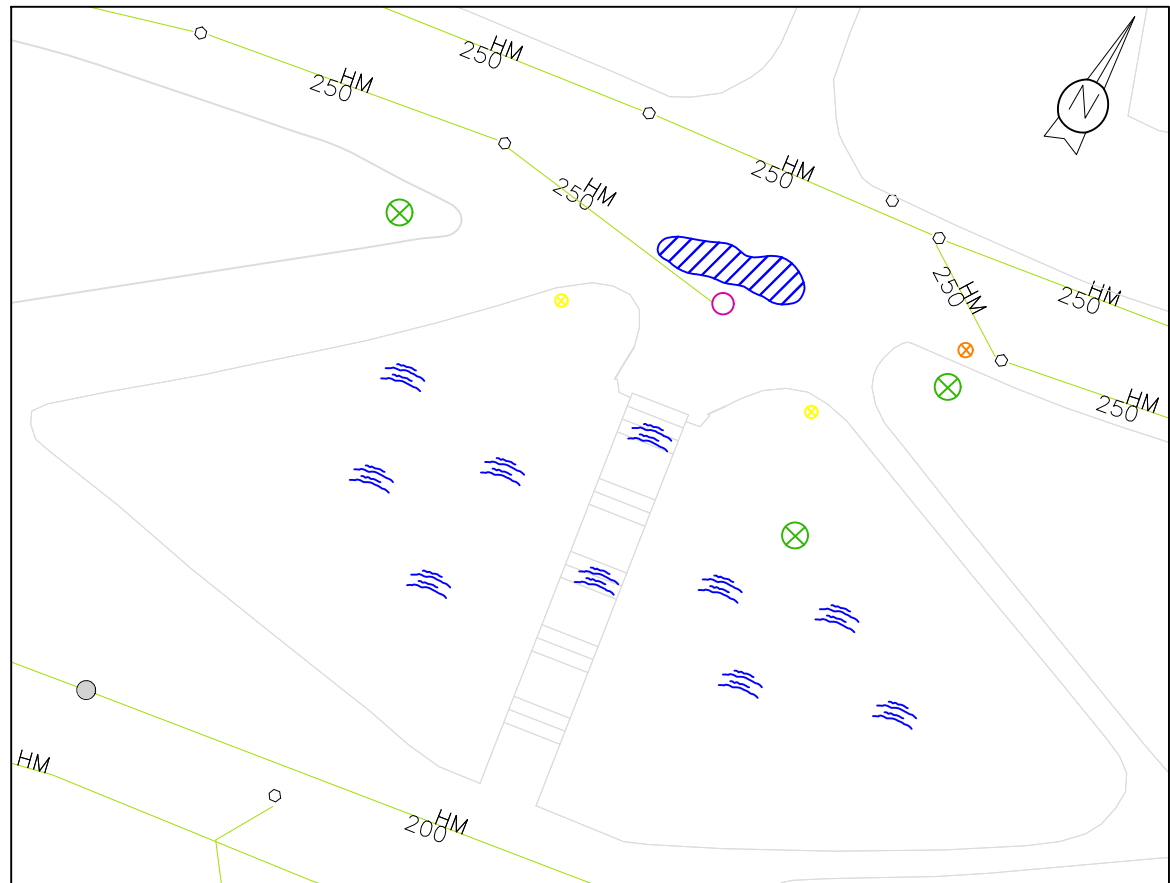

GAUR EGUNGO EGOERA
Oinplanta
E: 1:500

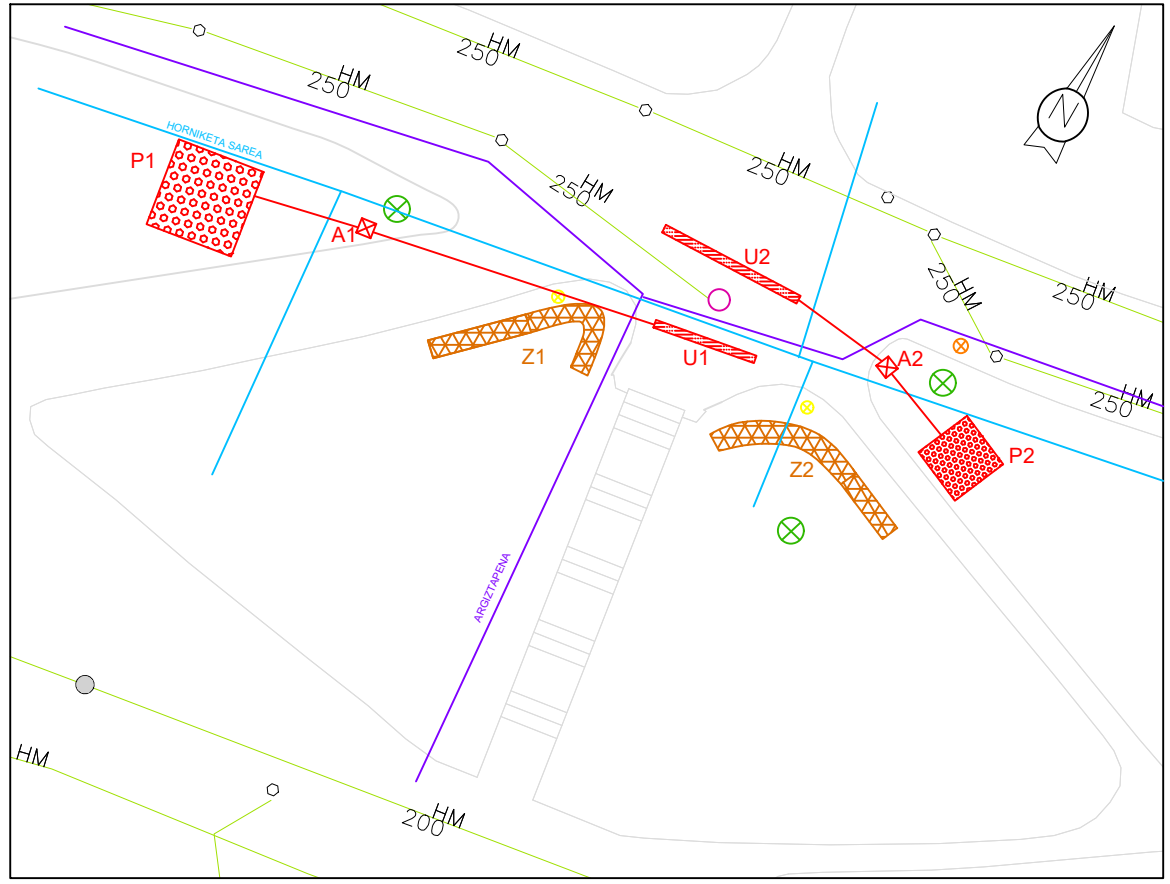

PROPOSATURIKO SOLUZIOA
Oinplanta
E: 1:500

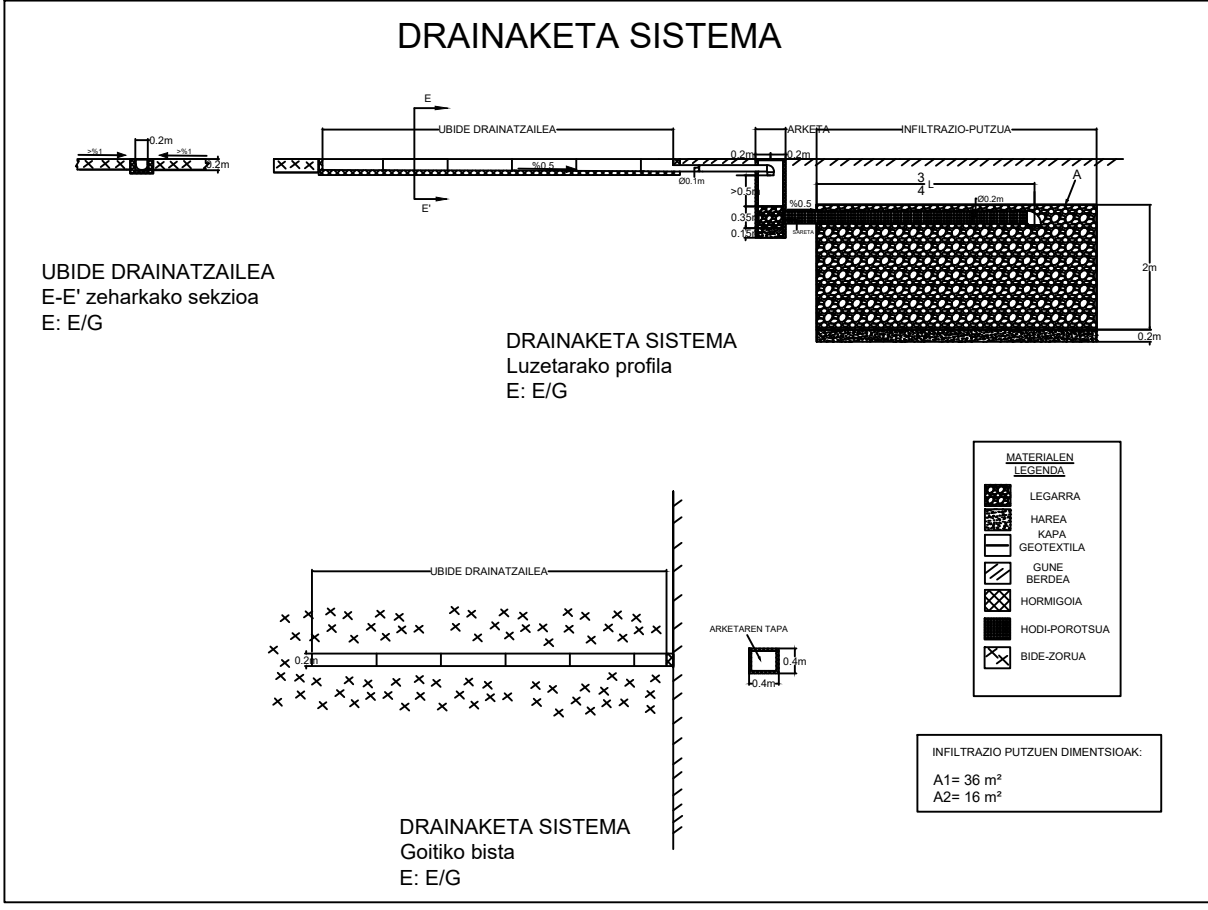
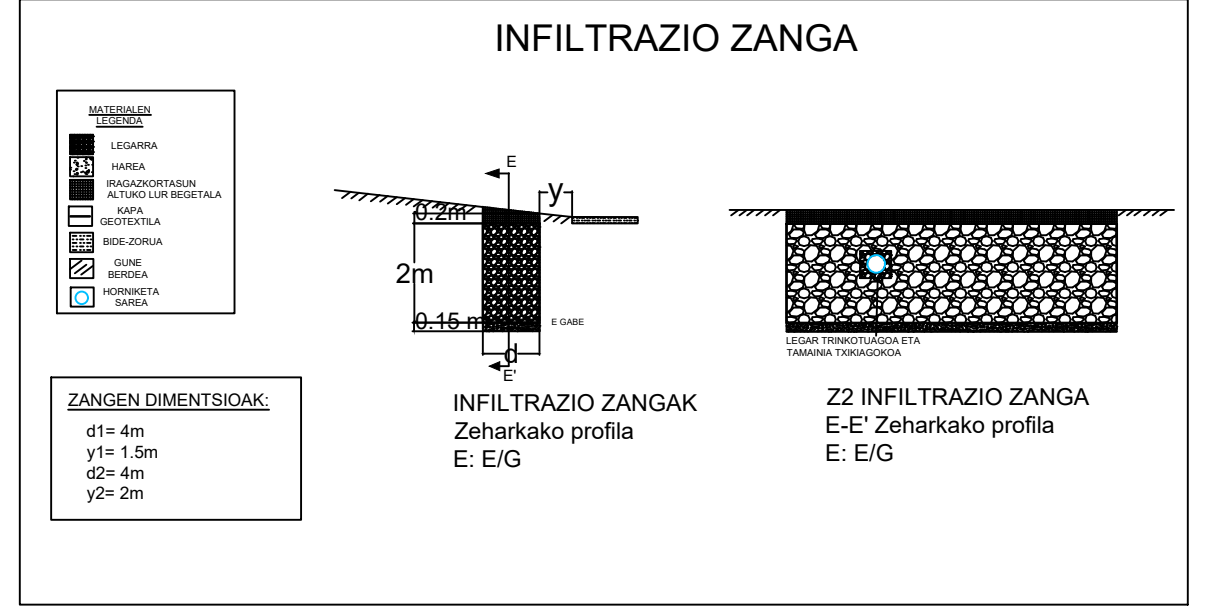

LEGENDA

- | | | |
|--|---|--|
| <ul style="list-style-type: none"> UR EDO/ETA SEDIMENTU METAKETA BANKUA ZUHAITZA HODITERIA BERRIA INFILTRAZIO-PUTZUA (P) | <ul style="list-style-type: none"> KALE-ARGIA ESTOLDA-PUTZUA ITURRIA ZAKARRONTZIA FEKAL SAREA | <ul style="list-style-type: none"> UR ISURKETA SANEAMENDU SAREA DRAINAKETA UBIDEA (U) ARKETA (A) INFILTRAZIO ZANGA (Z) |
|--|---|--|

EGILEA:
AUTOR: **JOSU SAN PEDRO VILLALBA**

PLANOA:
PLANO: **5.GUNEKO D ELKARGUNEA**

ERAKUNDEA:
INSTITUCIÓN: **EHU/UPV**

KOKAPENA:
UBICACIÓN: **EUROPA PARKEA (BILBO)**

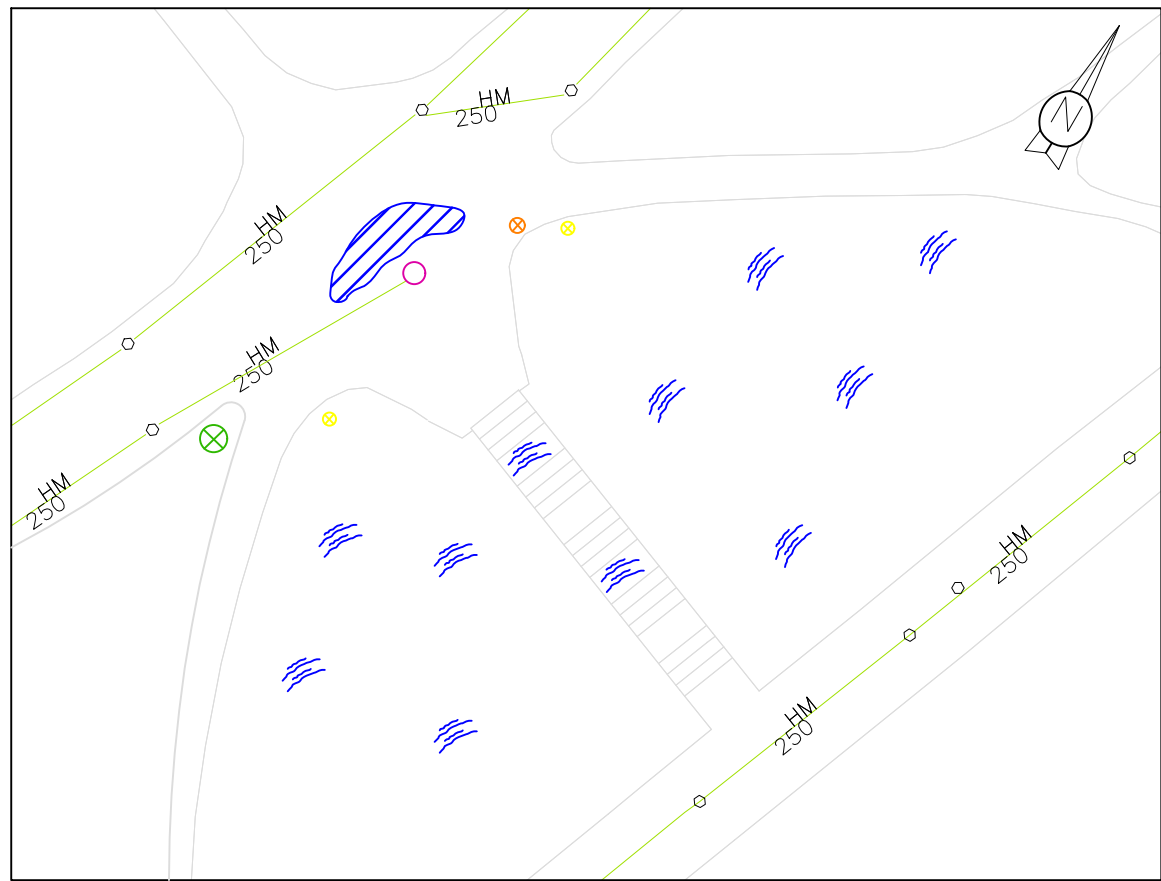

GAUR EGUNGO EGOERA
Oinplanta
E: 1:500

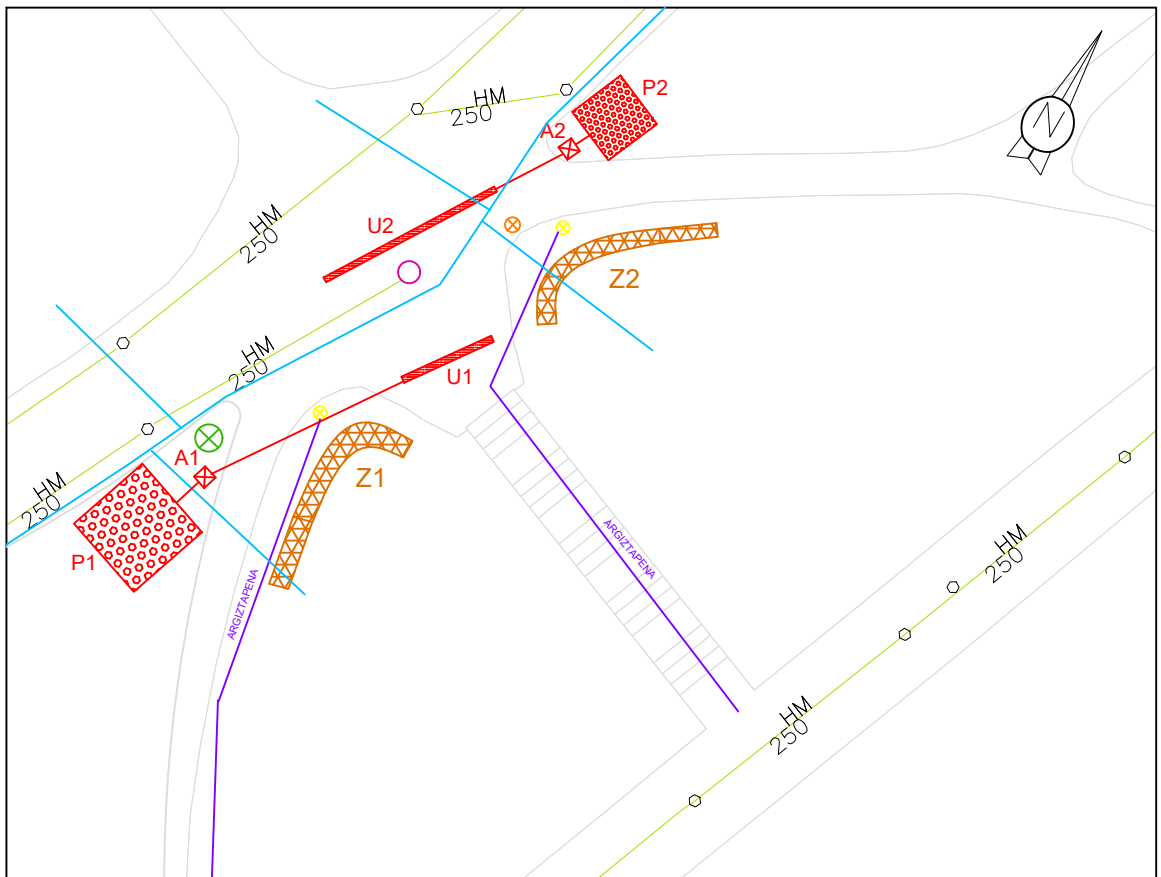

PROPOSATURIKO SOLUZIOA
Oinplanta
E: 1:500

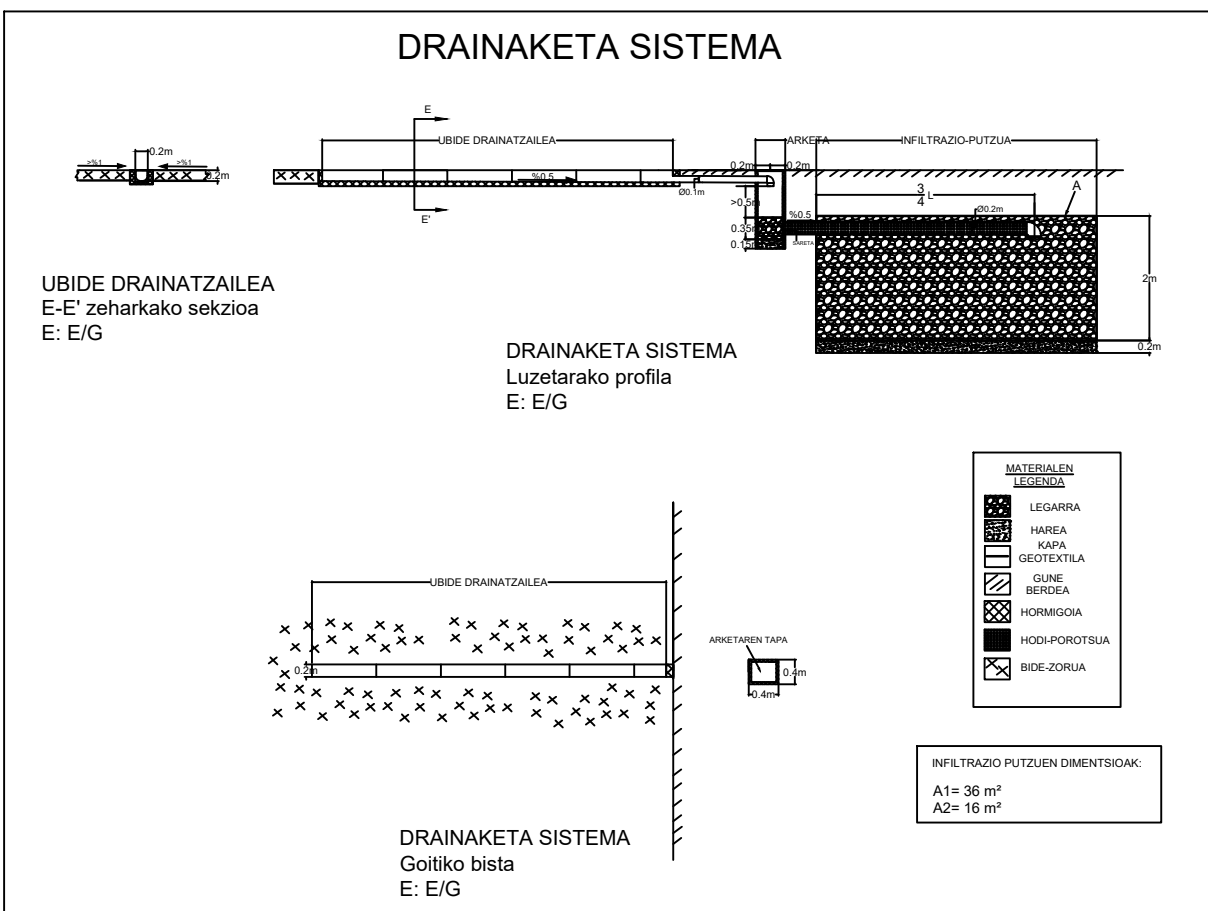
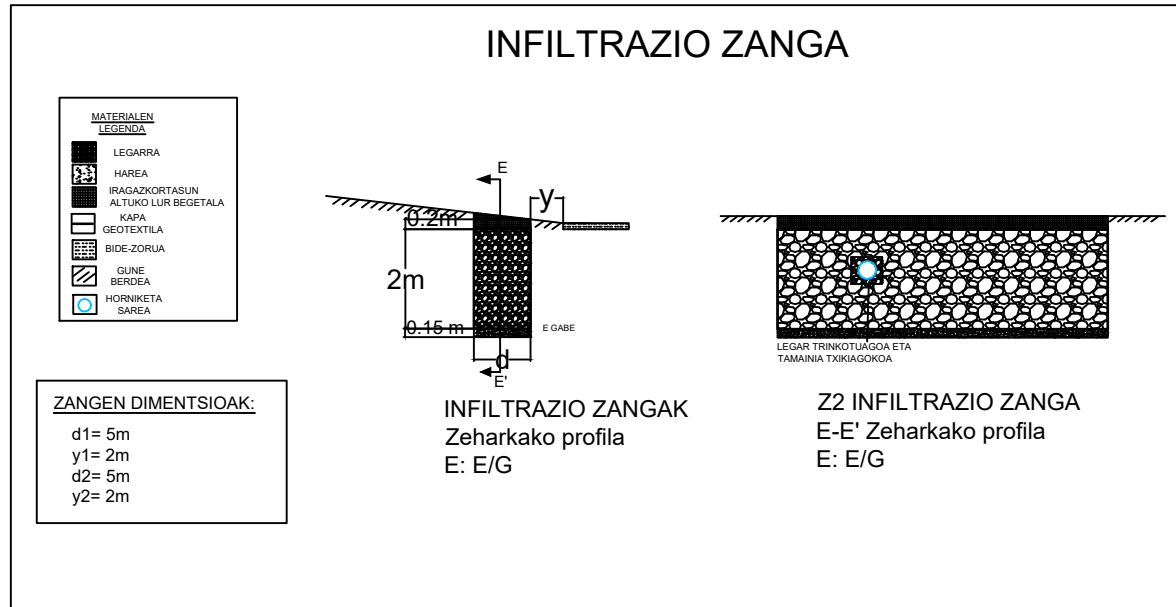

LEGENDA		
UR EDO/ETA SEDIMENTU METAKETA	KALE-ARGIA	UR ISURKETA
BANKUA	ESTOLDA-PUTZUA	SANEAMENDU SAREA
ZUHAITZA	ITURRIA	DRAINAKETA UBIDEA (U)
HODITERIA BERRIA	ZAKARRONTZIA	ARKETA (A)
INFILTRAZIO-PUTZUA (P)	FEKAL SAREA	INFILTRAZIO ZANGA (Z)

EGILEA: AUTOR: <p style="text-align: center;">JOSU SAN PEDRO VILLALBA</p>	PLANOA: PLANO: <p style="text-align: center;">5.GUNEO E ELKARGUNEA</p>
ERAKUNDEA: INSTITUCIÓN: <p style="text-align: center;">EHU/UPV</p>	KOKAPENA: UBICACIÓN: <p style="text-align: center;">EUROPA PARKEA (BILBO)</p>

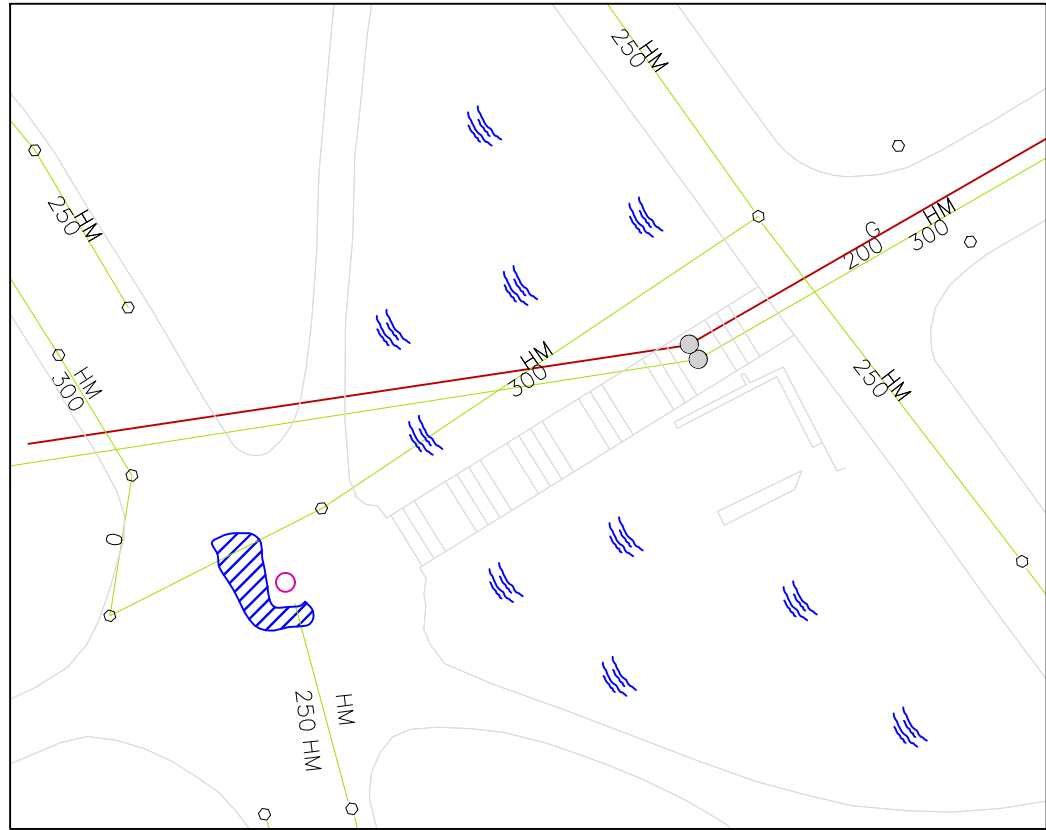

GAUR EGUNGO EGOERA
Oinplanta
E: 1:500

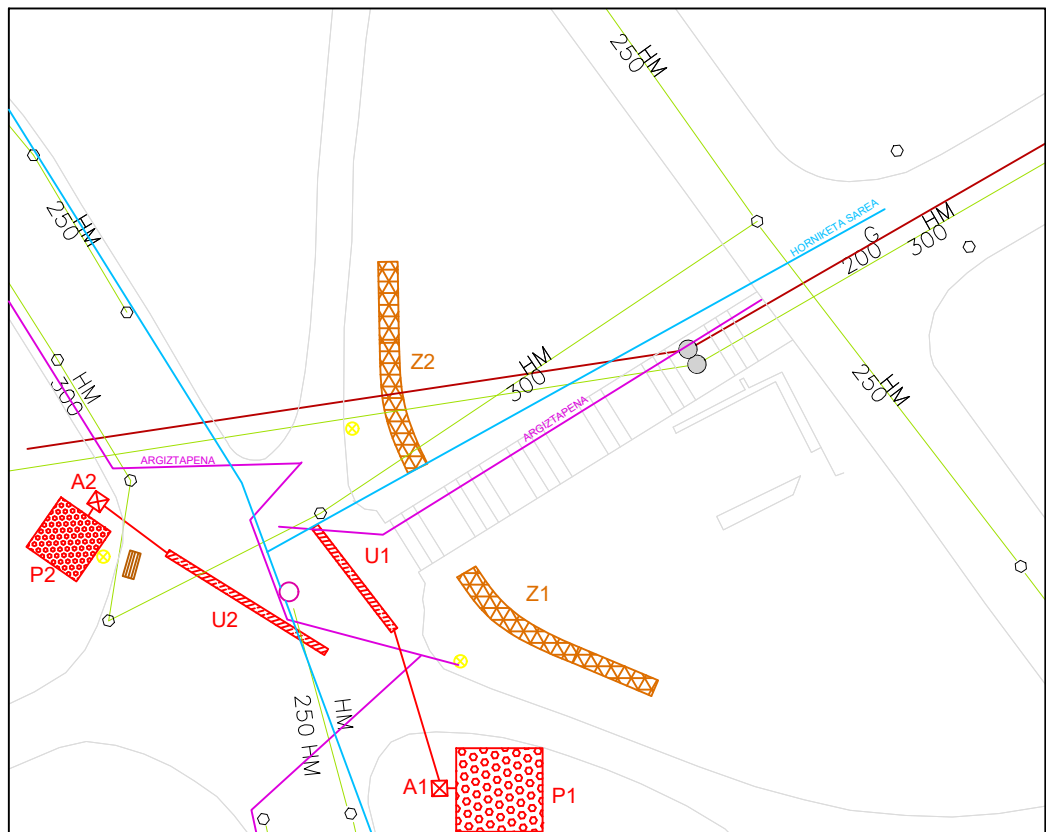

PROPOSATURIKO SOLUZIOA
Oinplanta
E: 1:500

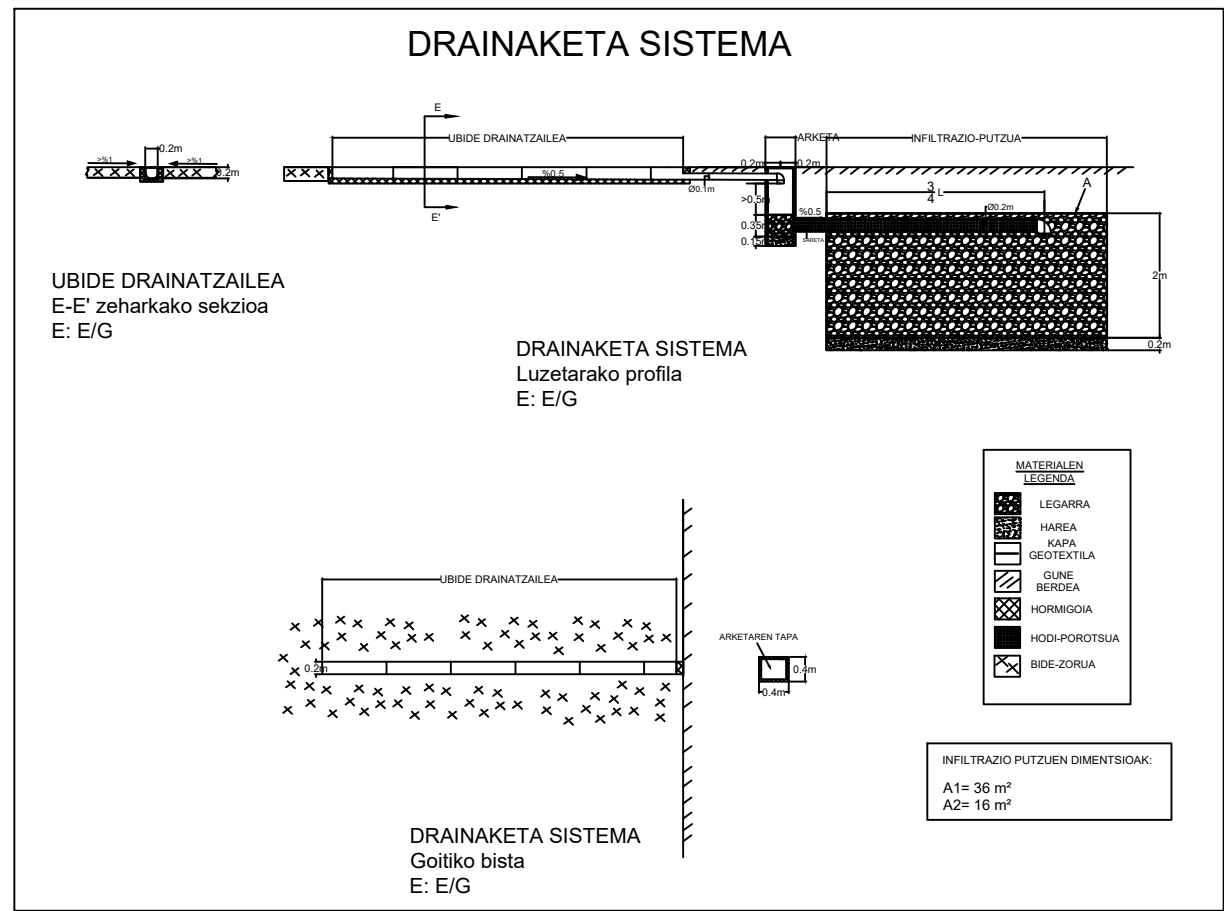
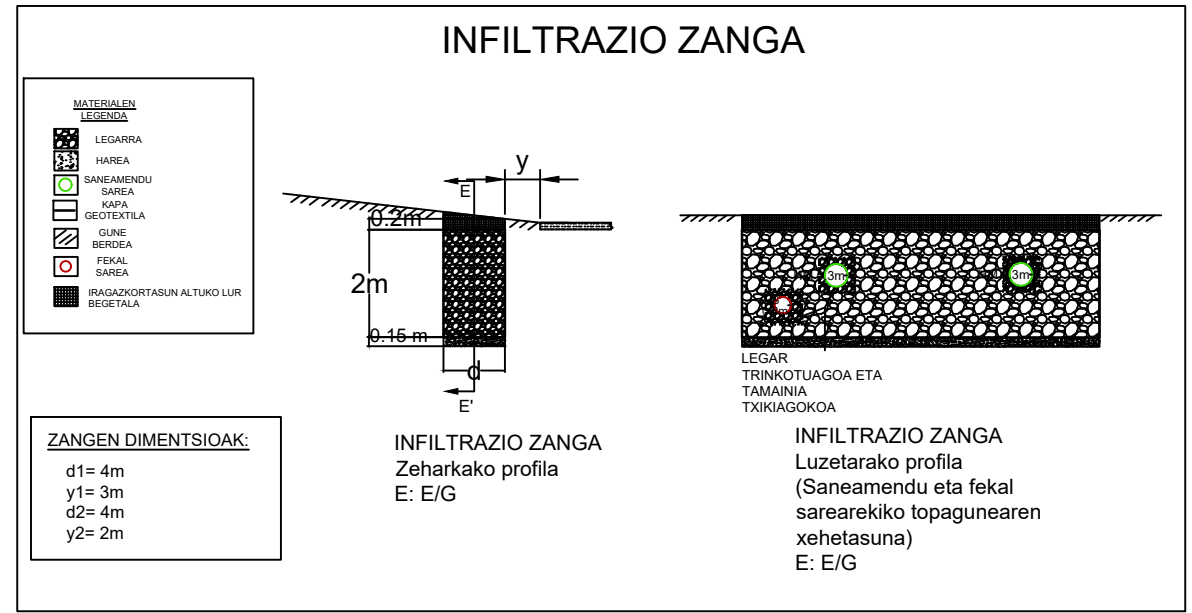

LEGENDA		

EGILEA: AUTOR:	JOSU SAN PEDRO VILLALBA
ERAKUNDEA: INSTITUCIÓN:	EHU/UPV

PLANOA: PLANO:	5.GUNeko F ELKARGUNEA
KOKAPENA: UBICACIÓN:	EUROPA PARKEA (BILBO)

CREADO CON UNA VERSION PARA ESTUDIANTES DE AUTODESK

CREADO CON UNA VERSION PARA ESTUDIANTES DE AUTODESK

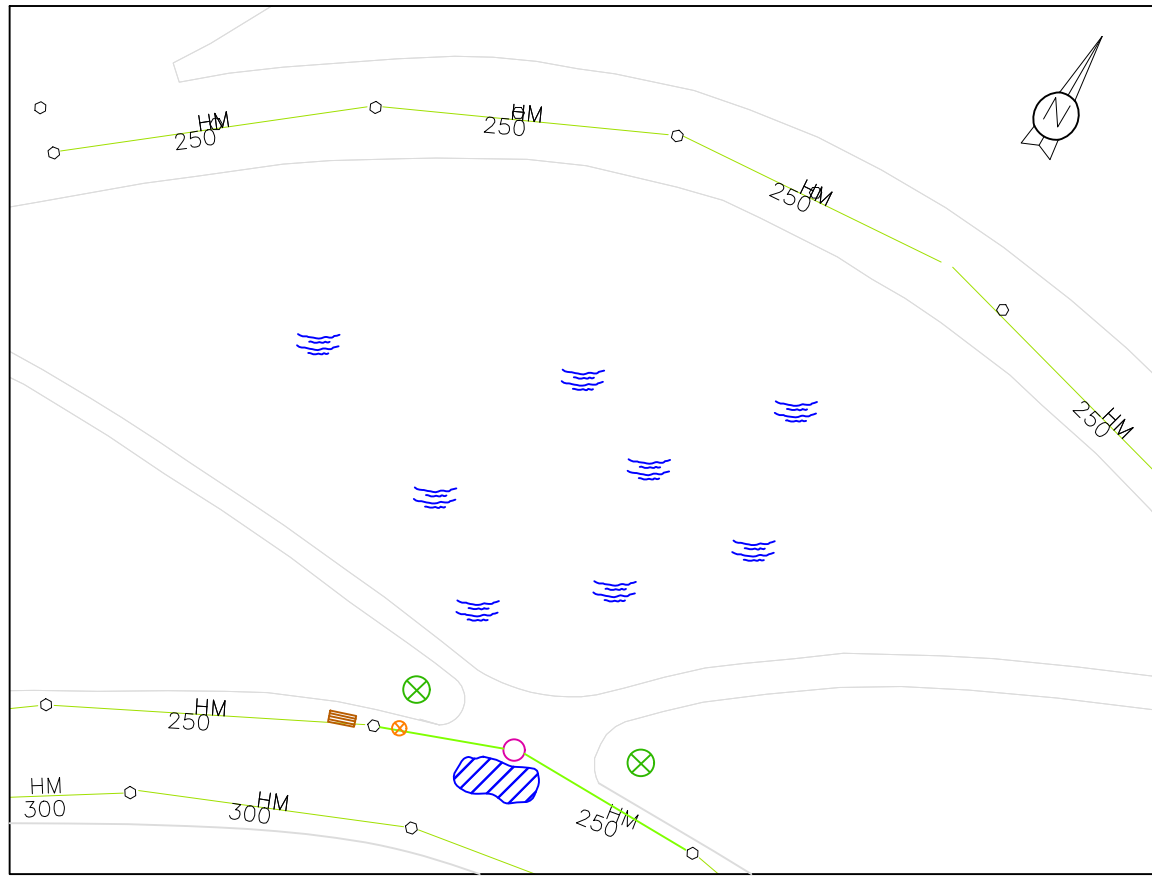

GAUR EGUNGO EGOERA
Oinplanta
E: 1:500

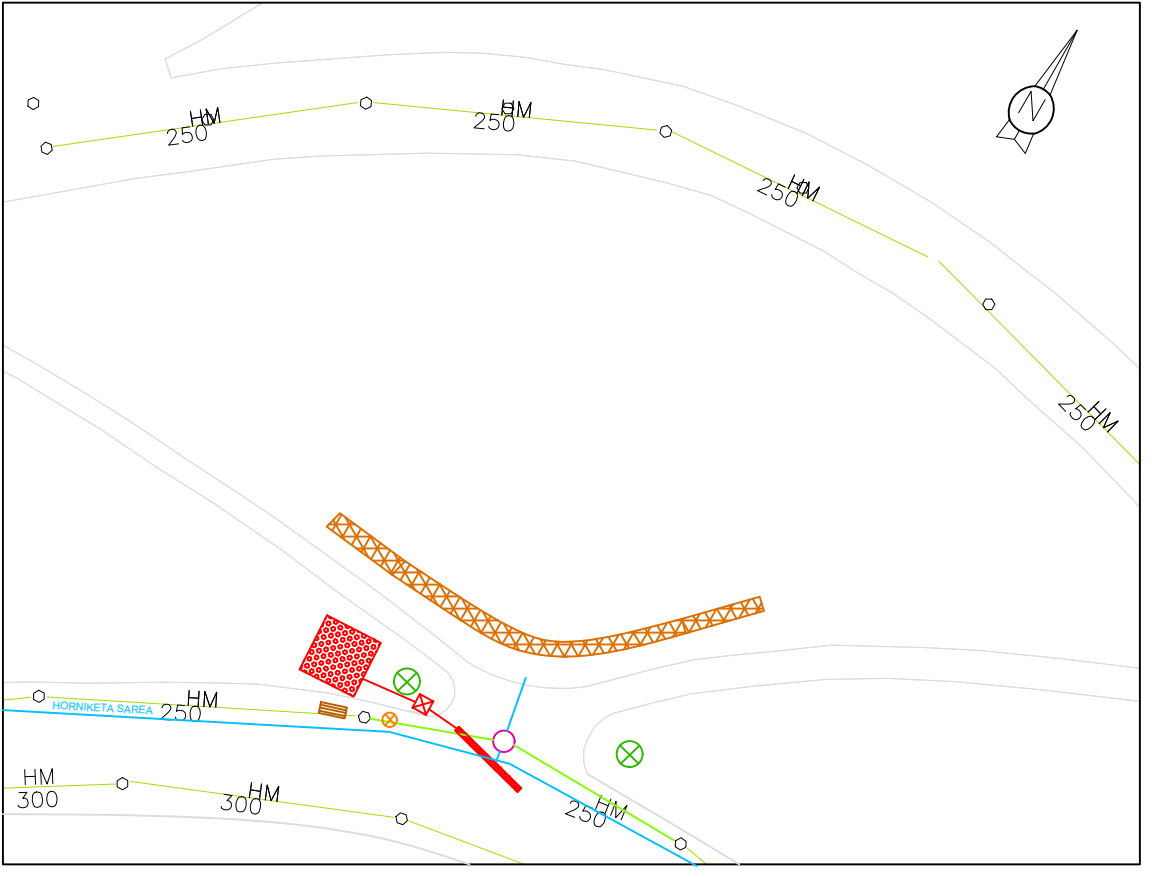

PROPOSATURIKO SOLUZIOA
Oinplanta
E: 1:500

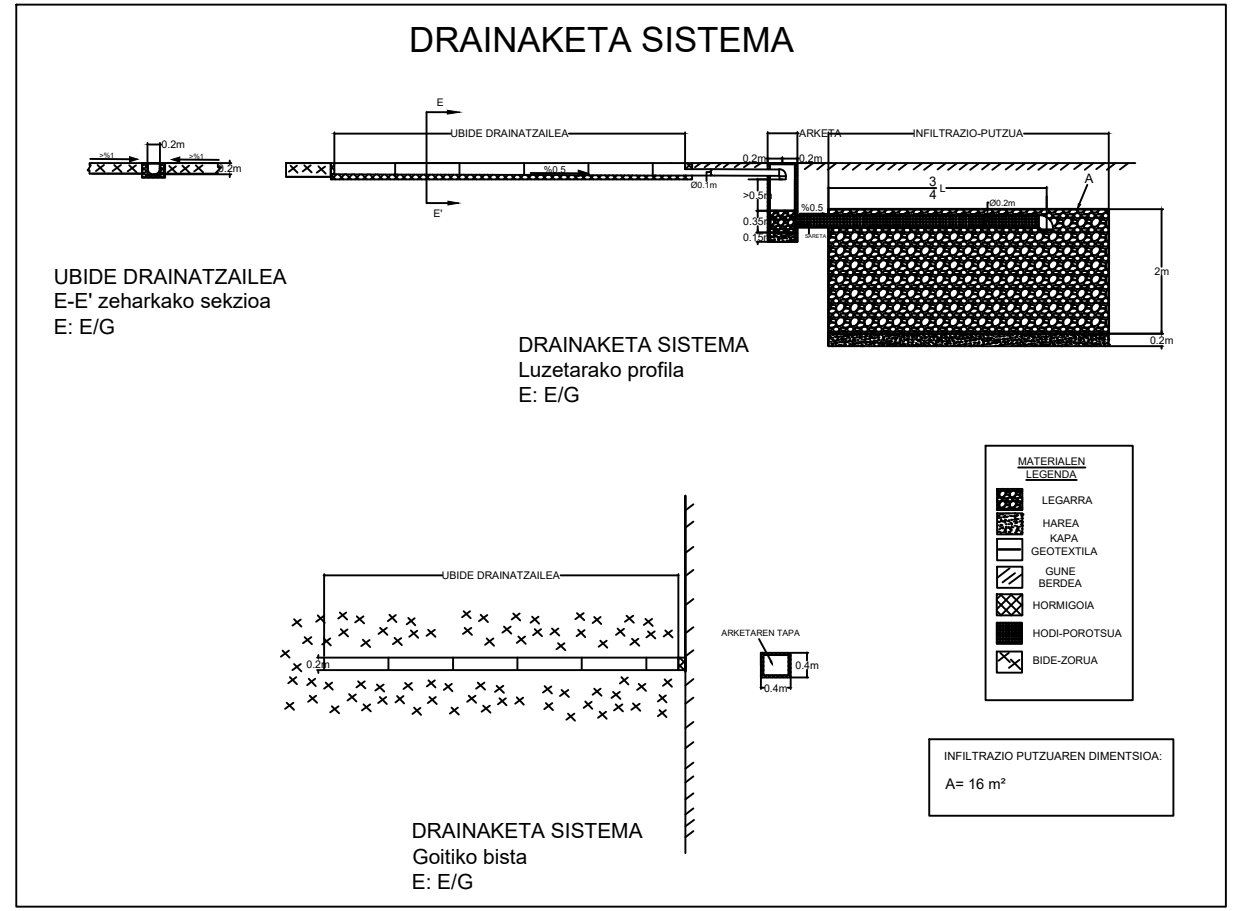
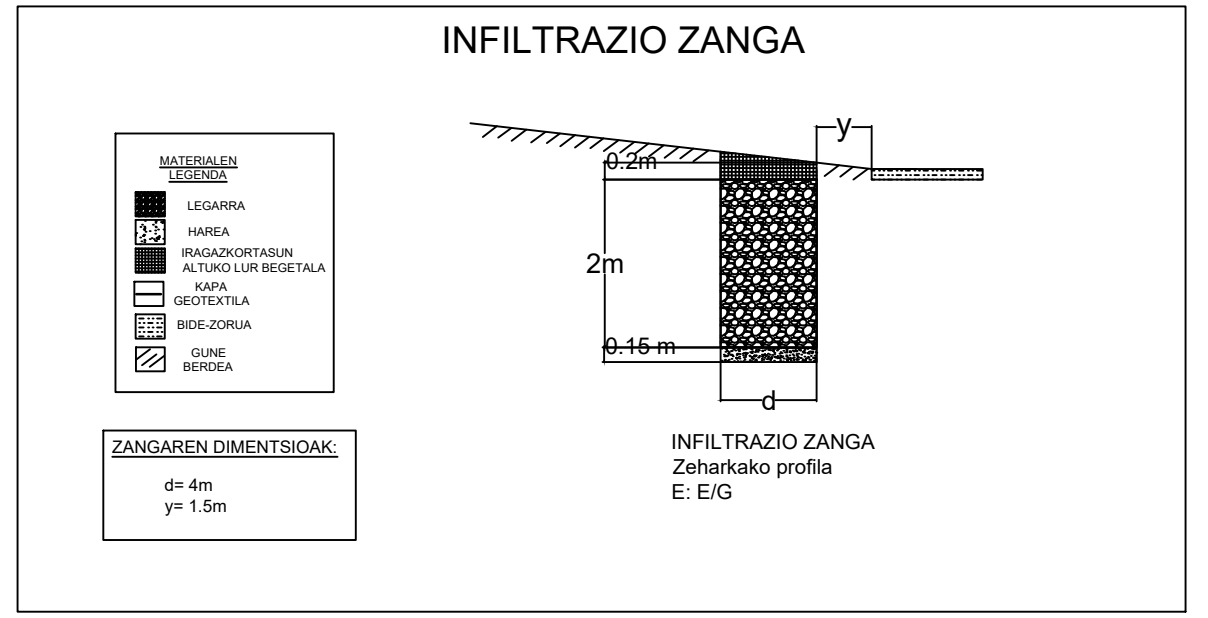

LEGENDA					
	UR EDO/ETA SEDIMENTU METAKETA		KALE-ARGIA		UR ISURKETA
	BANKUA		ESTOLDA-PUTZUA		SANEAMENDU SAREA
	ZUHAITZA		ITURRIA		DRAINAKETA UBIDEA
	HODITERIA BERRIA		ZAKARRONTZIA		ARKETA
	INFILTRAZIO-PUTZUA		FEKAL SAREA		INFILTRAZIO ZANGA

EGILEA:
AUTOR: **JOSU SAN PEDRO VILLALBA**

PLANOA:
PLANO: **5.GUNeko G ELKARGUNEA**

ERAKUNDEA:
INSTITUCIÓN: **EHU/UPV**

KOKAPENA:
UBICACIÓN: **EUROPA PARKEA (BILBO)**

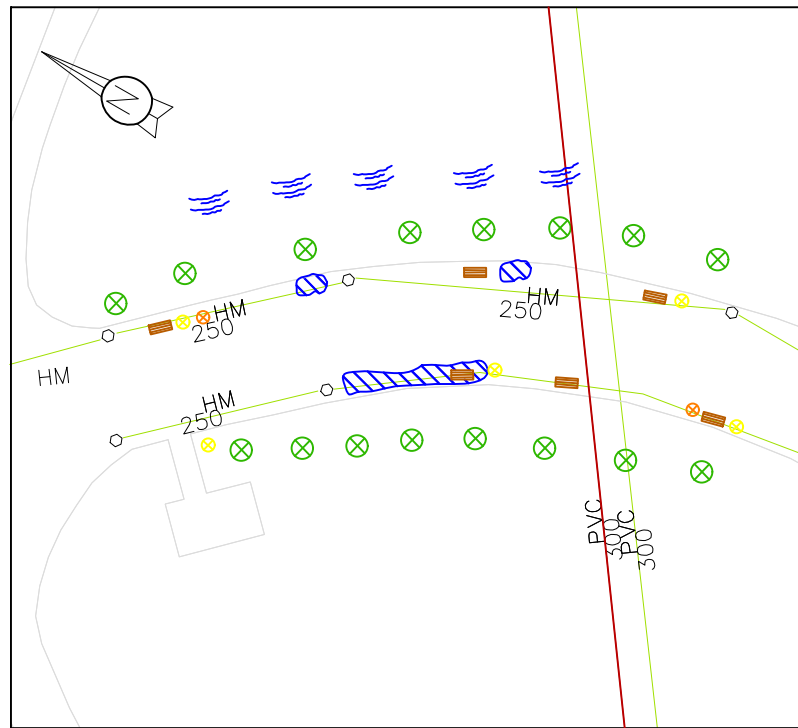

GAUR EGUNGO EGOERA
Oinplanta
E: 1:500

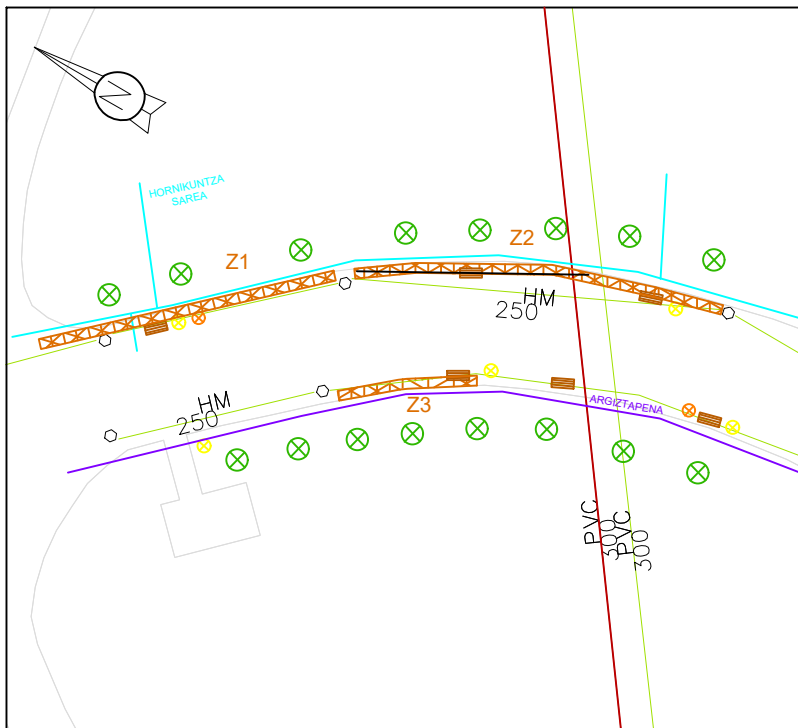

PROPOSATURIKO SOLUZIOA
Oinplanta
E: 1:500

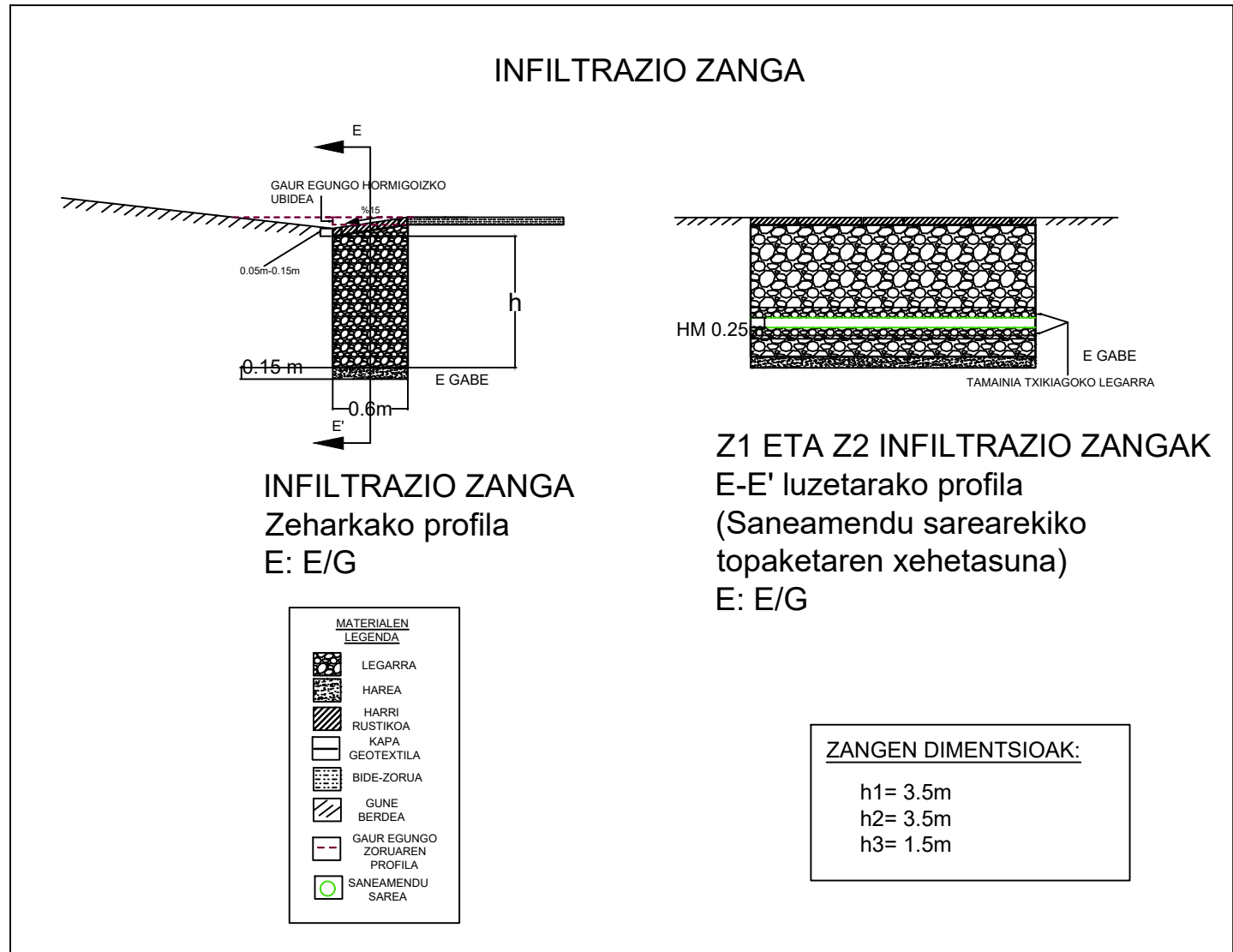

LEGENDA

- UR EDO/ETA SEDIMENTU METAKETA
- BANKUA
- ZUHAITZA
- HODITERIA BERRIA
- INFILTRAZIO-PUTZUA

- KALE-ARGIA
- ESTOLDA-PUTZUA
- ITURRIA
- ZAKARRONTZIA
- FEKAL SAREA

- UR ISURKETA
- SANEAMENDU SAREA
- DRAINAKETA UBIDEA
- ARKETA
- INFILTRAZIO ZANGA (Z)

EGILEA:
AUTOR: **JOSU SAN PEDRO VILLALBA**

ERAKUNDEA:
INSTITUCIÓN: **EHU/UPV**

PLANOA:
PLANO: **6.GUNEA**

KOKAPENA:
UBICACIÓN: **EUROPA PARKEA (BILBO)**